



Electrolux

Explore 7 Compact Blender

E7CB1-50CW

E7CB1-52CW

E7CB1-53CW

E7CB1-56CW

E7CB1-50GB

E7CB1-52GB

E7CB1-53GB

E7CB1-56GB

E7CB1-80FG

E7CB1-82FG

E7CB1-83FG

E7CB1-86FG

E7CB1-80SM

E7CB1-82SM

E7CB1-83SM

E7CB1-86SM

EN INSTRUCTION BOOK

CNS 说明书

CNT 說明手冊

KR 사용 설명서

ID Buku Panduan

TH คู่มือแนะนำการใช้งาน

VN Sách Hướng Dẫn



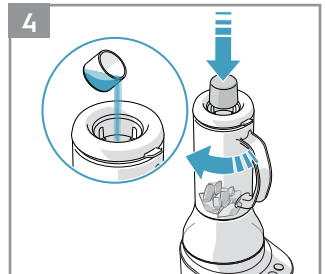
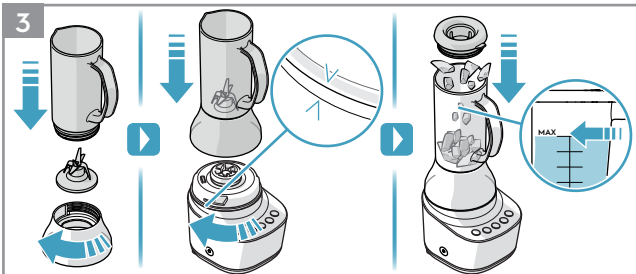
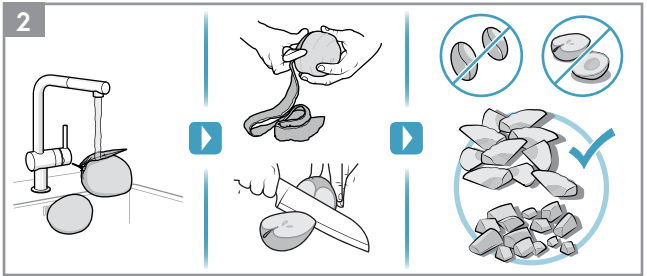
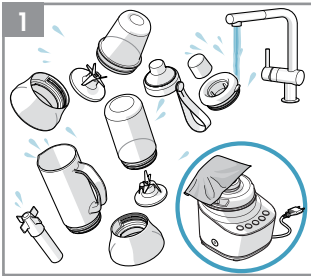
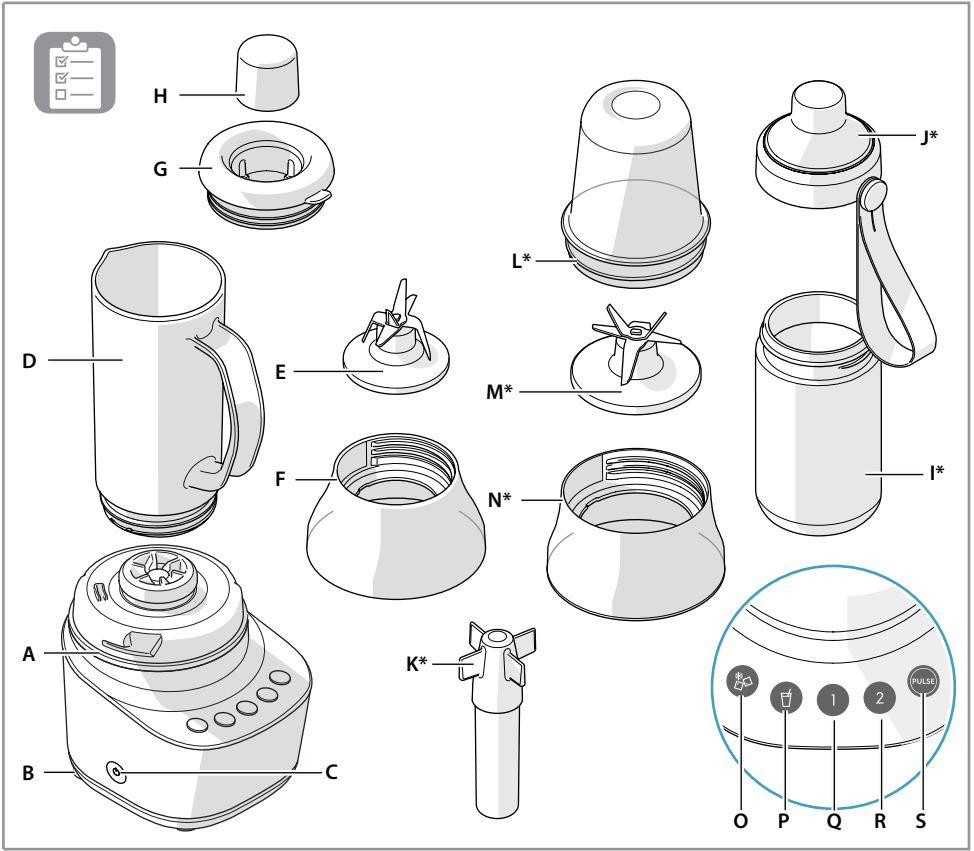

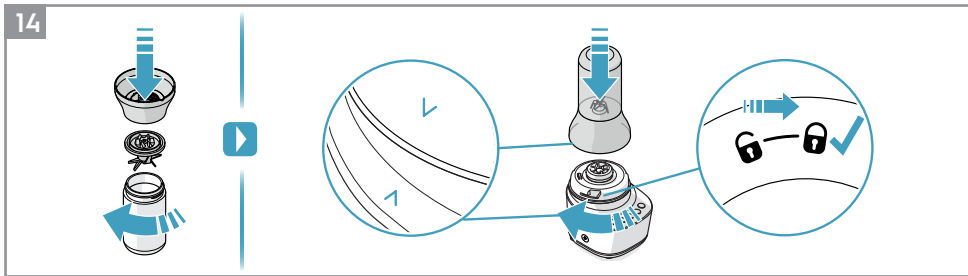
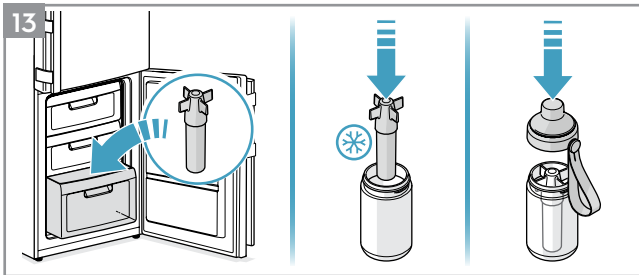
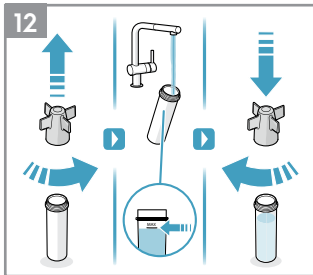
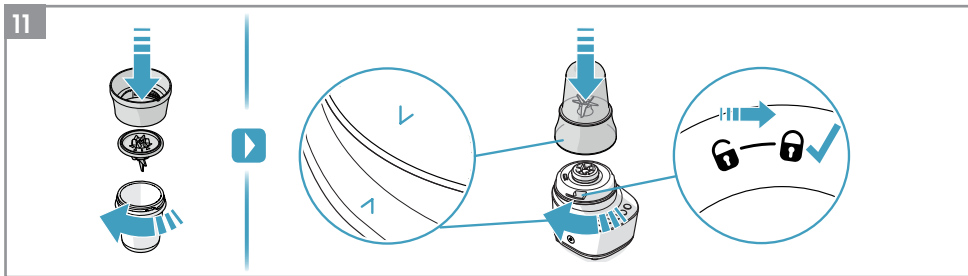
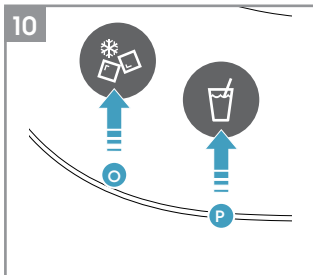
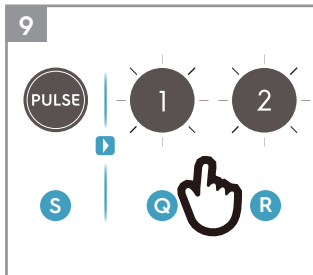
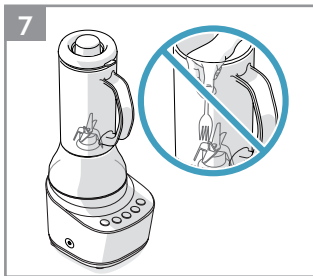
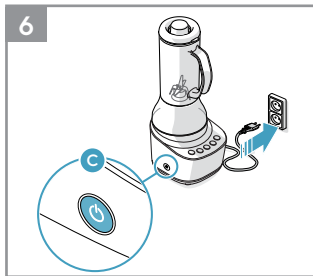
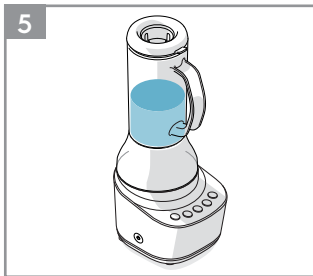

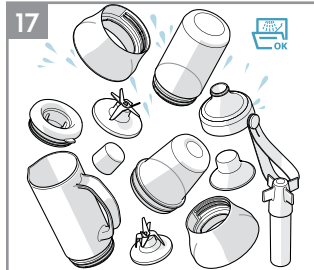
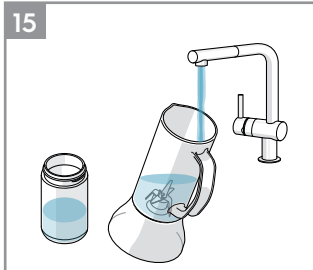

Thank you for choosing an Electrolux product. In order to ensure the best results, always use original Electrolux accessories and spare parts. They have been designed especially for your product. This product is designed with the environment in mind. All plastic parts are marked for recycling purposes.

INSTRUCTION MANUAL

Graphics and drawings in this manual are solely for illustration purposes and are subject to variations from actual product.

Read all instructions carefully before using the appliance for the first time.

Keep this manual for future reference.

COMPONENTS

- | | | |
|---|--|----------------------------|
| A. Blender base | H. Measuring cup | O. Ice Crush button |
| B. Suction feet | I. Take away bottle* | P. Smoothie button |
| C. ON/OFF-button | J. Drinking lid with carry handle* | Q. "Speed 1" button |
| D. Mini jug | K. Cooling stick* | R. "Speed 2" button |
| E. Blender blade assembly, with sealing ring | L. Multi-chopper jar* | S. PULSE button |
| F. Base for blender blade assembly | M. Multi-chopper blade assembly, with sealing ring* | *Certain models only |
| G. Mini jug lid with filler hole | N. Base for multi-chopper blade assembly* | |

PICTURE PAGE 2-4

SAFETY ADVICE

- Remove and safely discard any packaging materials before using the appliance.
- This appliance is not intended for use by persons (including children) with reduced physical, sensory or mental capabilities, or lack of experience and knowledge, unless they have been given supervision or instruction concerning the use of the appliance by a person responsible for their safety.
- Keep the appliance and its power cord out of reach of children. Children should be supervised to ensure that they do not play with the appliance.
- Cleaning and maintenance should not be performed by children unless they are supervised.
- The appliance can only be connected to a power supply which voltage and frequency comply with the specifications on the rating plate.
- Never use or pick up the appliance if the power cord is damaged and/or the housing is damaged.
- If the appliance or its power cord is damaged, it must be replaced by Electrolux or its service agent in order to avoid hazard.
- Do not immerse the appliance, its power cord or plug in water or any other liquid.
- Do not use or place the appliance near the edge of the table or counter, near hot gas, stove, electric burner or heated oven.
- Always place the appliance on a flat, level and dry surface.
- Always switch off the appliance and disconnect it from the power supply if it is left unattended and before changing of the accessories, cleaning or maintenance.
- The blades and inserts are very sharp. Danger of injury. Care shall be taken when changing accessories, after use and during cleaning and maintenance.
- Never touch the blades or inserts with your hand or with any utensils while the appliance is plugged in and/or during operation.
- Do not attempt to remove the blade assembly.
- Keep hands and utensils away from the appliance during operation to avoid the risk of severe injury to persons or damage to the appliance.
- Ensure that the appliance is switched off before removing the jug from the motor base.

- Do not operate the appliance without food or liquid in the jug.
- Never operate the appliance without the lid.
- Do not use the appliance continuously for more than 1 minutes when processing heavy load.
- The jug cannot be used for blending or grinding hard and dry substances, except for ice cubes. Use the multi-chopper to grind hard and dry substances (Eg. nuts, candy, rice etc..)
- Be careful if hot liquid is poured into the appliance as it can be ejected out of the appliance due to a sudden steaming.
- Never process boiling liquids (max 90°C).
- Do not exceed the maximum filling volume as indicated on the appliance.
- Do not use this appliance to stir paint. Danger, could result in an explosion!
- Do not let the power cord come into contact with hot surfaces or hang over the edge of a table or counter.
- Never use accessories or parts made by other manufacturers not recommended or sold by Electrolux as it may cause a risk of injury to persons.
- This appliance is for indoor use only.
- This appliance is intended for domestic use only. Electrolux will not accept any liability for possible damage caused by improper or incorrect use.
- If the appliance is left on without using any speed or programs, it will automatically switch off after 5 minutes.
- CAUTION: In order to avoid a hazard due to inadvertent resetting of the thermal cut-out, this appliance must not be supplied through an external switching device, such as a timer, or connected to a circuit that is regularly switched on and off by the utility.

GETTING STARTED

- 1 Before using your appliance for the first time:** Remove all packing material such as plastics, stickers or tags that may be attached to the housing, bowls or attachments. Clean the appliance and accessories, see instructions: "Cleaning and Care".
- 2 Prepare the ingredients:** Rinse ingredients thoroughly. Cut the ingredients into 4 to 6 pieces and remove any hard or large seeds. Remove any thick peel from the fruit or vegetables.
- 3** Place the blender blade assembly (E) on the top of the blender blade assembly base (F) and tighten the jug (D) until it firmly locks into position. Place the assembled jug on the blender base (A) and rotate it clockwise until it locks into position. (The jug can only be placed in one position). When locked, the symbol **V** on the blade assembly base should be aligned with the **^** symbol on the blender base. Put the ingredients in the jug. (Do not exceed the maximum level as indicated on the jug.)
Caution! Always place the sealing ring around the blender blade assembly before operating the product. Use only sealing rings provided by Electrolux!
- 4 Close the lid by aligning the lever on the lid with the handle of the jug. Insert the measuring cup.** (You can add ingredients through the filler hole after you started processing. Never remove the measuring cup or the lid while running the product)
Caution! Never run the blender empty. When processing hot liquids, see step 5.
- 5 Processing hot liquids:** We recommend to allow hot liquids to cool down (max 90 °C) before filling the jug. Fill the jug only half full and start processing on low speed. The blender jug can become very warm - take care to protect your hands and to ventilate steam out through the filler hole. Always replace the lid before use.
- 6 Start the blender:** Plug into mains. Press the ON/OFF-button (C), the buttons will light up. Press the speed 1 or speed 2 button, to select your desired processing speed.
- 7 Caution! Keep hands and utensils out of the blending jug while blending.**
Caution! Never run the blender empty, running the blender empty can cause overheating and damage the product.

- 8** You have preset speeds (1, 2), dedicated recipe programs, and Pulse mode to choose from. The selected speed or recipe program will light up. The blender will operate until the program is finished. To stop any program manually, press any button.
- 9** You can give the ingredients a quick mix to get to your desired consistency with the Pulse function. Press the PULSE button(S) to go into Pulse mode. The PULSE and the speed buttons start blinking. Press 1 or 2 to pulse at different speeds.
- 10** The product comes with a variety of recipe programs. You can choose between Ice crush (O) and Smoothies (P). The blender will stop automatically when the program is ready.

USING THE MULTI-CHOPPER* (* CERTAIN MODELS ONLY)

- 11** Turn the multi-chopper (J) upside down, with the open end facing upwards. Carefully remove the base for blade assembly (N) by rotating it clockwise, then remove the blade assembly (M). Fill the multi-chopper jar with the desired ingredients. Do not fill more than half full. Place the multi-chopper blade assembly (I), followed by the multi-chopper blade assembly base on the open end of the jar and rotate clockwise to fasten the jar. Turn the multi-chopper the right way up and lock into place on the blender base by rotating clockwise.
- Caution!** Always place the sealing ring around the blender blade assembly before operating the product. Use only sealing rings provided by Electrolux!
- Note:** When locked, the symbol **V** on the multi-chopper blade assembly base should be aligned with the symbol **Λ** on the blender base.

USING THE TAKE AWAY BOTTLE* (* CERTAIN MODELS ONLY)

- 12** Fill the ingredients in the take away bottle (I). Place the blender blade assembly (E) on the open end of the jar and tighten the blender blade assembly base (F) by screwing it on the jar. Turn the take away bottle upside down. Place the assembled take away bottle onto the blender base (A) and rotate it clockwise to lock until it clicks into position.
- Note:** When locked, the symbol **Λ** on blender blade assembly base should be aligned with the symbol on the **V** blender base.
- Caution!** The blades are very sharp!

USING THE COOLING STICK* (* CERTAIN MODELS ONLY)

- 13** The cooling stick keeps your smoothies cool for longer. Unscrew the cap of the cooling stick (K) and fill it with tap water. Screw the cap back on the cooling stick and place it in the freezer until the water freezes.
- 14** Place the frozen cooling stick in the take away bottle. Pour your freshly prepared blend into the take away bottle (I) and fasten with the drinking lid with carry handle (J). The cooling stick can be cleaned in a dishwasher.

CLEANING AND CARE

To avoid crazing of the jug, always rinse the jug with only clean water right after usage. This is to prevent acids or essential oils from the ingredients that may attack the plastic material. After rinsing the jug, it can be washed by hand with detergent, or placed into the dishwasher for cleaning. Avoid leaving the ready dishes (e.g. soup, smoothie, juice) in the jug for a long time, especially when acidic ingredients (e.g. lime, lemon) is processed. However, if crazing would appear, the effect is purely cosmetic and it does not have any impact the integrity of the jug.

- 15** Always rinse the jug thoroughly with only clean water before placing it to the dishwasher. **Quick cleaning:** Pour warm water into the jug, add a few drops of detergent. Mix water and detergent by pressing the PULSE button then speed 2 button a couple of times. Finally, rinse the jug under running water.

- 16 **Thorough cleaning of the blender base and interface:** Switch off the blender and unplug the power cord. Wipe the blender base with a damp cloth.

 **Warning!** Never immerse the blender base, plug, or cord in water or any other fluid.

- 17 **Thorough cleaning of the jug: Note! The Blade assembly is not removable.** Remove the lid and measuring cup. Rinse the blade assembly in water and detergent.

Caution! Handle carefully, the blades are very sharp!



 All parts, except for the blender base are dishwasher safe.

Enjoy your new Electrolux product!

RECIPES

When using the multi-chopper to chop ingredients like onions and shallots, cut the ingredients into cubes no bigger than 2.5 cm to get the best result. Ingredients with tough textures such as carrot and celery are not recommended for chopping.

MAXIMUM PROCESSING TIME	MAXIMUM CAPACITY
1 min	500 ml

RECOMMENDED BLENDING SPEED				
Recipe	Ingredients	Quantity	Time	Speed setting
Pureeing raw vegetables	Carrots	20-80 g	30 s	2 (Max speed)
	Potatoes	20-80 g		
	Onions	20-80 g		
	Water	60-120 g		
Pineapple-apricots Smoothie	Pineapple in slices	200 g	≤ 60 s	2
	Dried Apricots	20 g		
	Yoghurt	250 g		
Soup for mini jug	Carrots	250 g	≤ 60 s	2
	Water	350 ml		
Soup for take away bottle	Carrots	210 g	≤ 60 s	2
	Water	290 ml		
Raspberries Smoothie	Frozen raspberries	150 g	Program set	
	Banana (½ pcs)	50 g		
	Water	50 g		
	Yoghurt	250 g		
Milkshake	Milk	100-200 ml	Program set	
	Vanilla Ice cream	100-150 ml		
	Banana	¼ - ½ pcs		
	Chocolate syrup	30-60 g		
Potato leek soup	Potatoes	60 g	2	
	Leek	60 g		
	Water	180 g		
Chunky guacamole	Firm-ripe avocados	2 pcs	PULSE + 1	
	Red onion	1 pcs		
	Fresh cilantro leaves	1/4 cup		
	Fresh lime juice	1 and 1/2 tbsp		
	Salt	1 pinch		

RECOMMENDED BLENDING SPEED

Recipe	Ingredients	Quantity		Time	Speed setting
Chunky pesto	Fresh basil	30	g	≤ 30 s	2
	Olive oil	108	g		
	Pine nuts	16	g		
	Minced garlic	10	g		
	Salt	6	g		
	Grated Parmesan cheese	50	g		
	Grated Romano cheese	30	g		
	Butter	42	g		
Semi-smooth hummus	Canned chickpeas	200	g		2
	Lemon juice	2	tblsp		
	Garlic cloves, crushed	2	pcs		
	Ground cumin	1	tsp		
	Salt	1	pinch		
	Tahini (sesame seed paste)	1	tblsp		
	Water	4	tblsp		
	Extra virgin olive oil	2	tblsp		
	Paprika	1	tsp		

MULTI-CHOPPER FUNCTION

Maximum volume for multi-chopper cup: 400 ml		Maximum dry grinding time: 30 s	
Ingredients	Maximum Quantity	Time	Speed setting
Coffee	60 g	20-30 seconds	2
Dry shrimp	50 g	10 seconds ON + 3 seconds OFF (2 times)	2
Dry chili	20 g	10 seconds ON + 3 seconds OFF (2 times)	2
Fresh chili	50 g	10 seconds ON + 3 seconds OFF (2 times)	2
Pepper corn	100 g	10 seconds ON + 3 seconds OFF (2 times)	2
Dry anchovy	50 g	10 seconds ON + 3 seconds OFF (2 times)	2
Raw rice	100 g	10 seconds ON + 3 seconds OFF (2 times)	2
Five spice	50 g	10 seconds ON + 3 seconds OFF (2 times)	2
Garlic	50 g	5 seconds ON + 3 seconds OFF (5 times)	2
Nuts	80 g	5-10 seconds	2
Almonds	80 g	5-10 seconds	2
Onions	100 g	5-10 seconds	2
Beef	100 g	5-10 seconds	2

TROUBLESHOOTING

SYMPTOM	CAUSE	SOLUTION
The blender does not switch on.	Jug/base are not fixed properly.	Check if all the components are in correct position. Note! the jug can only be placed on the base with handle towards the user interface.
	The ON/OFF-button is not pressed.	Press the ON/OFF button to switch on the blender. The control panel will illuminate when the blender is switched on.
	The motor has overheated. The display is blinking.	Wait until the product has cooled down and all the buttons are lit.
	The plug is not properly connected to the power outlet	Check the connection of the plug to the outlet or try another outlet.
	Power outage.	Wait until power outage is over.
	Functional problem.	Contact authorized service.
The motor stalls during operation		If the motor stalls, switch off the blender immediately, unplug the appliance and let it cool for at least 10 minutes.
	Ingredients are too large.	Cut all firm fruits and vegetables into pieces no larger than 1.8 cm ² to 2.5 cm ² .
	Wrong ingredients.	The appliance intended use is production of beverages. Add fruits, vegetables or similar. Never mix ingredients such as dough, mashed potatoes, meat or similar in the mini jug.
If the appliance is still not working, please contact Electrolux Customer Service.		

DISPOSAL

Recycle the materials with the symbol . Put the packaging in applicable containers to recycle it. Help protect the environment and human health and to recycle waste of electrical and electronic appliances.



Do not dispose appliances marked with the symbol  with the household waste. Return the product to your local recycling facility or contact your municipal minice.

CUSTOMER CARE AND SERVICE

When contacting Service, ensure that you have the following data available: **Model, PNC, Serial Number**. The information can be found on the rating plate.

Due to the Electrolux policy of continual product development; specifications, colours, and details of our products and those mentioned in this manual are subject to change without notice.

感谢您选用伊莱克斯产品。为确保最佳结果，请始终使用伊莱克斯的原装配件和零部件。它们是专门为您的产品而设计。该产品的设计充分考虑了环境因素。所有塑料部件都被标记为可回收循环使用。

说明书

手册内的插图仅做说明使用，可能与实际产品不同。

首次使用本电器前，请仔细阅读下列说明。

保留此说明书以便将来参考。

组件图标

A. 果汁料理机机座	I. 随行杯*	P. 冰沙按键
B. 防滑脚垫	J. 随行杯杯盖附拎手*	Q. “速度1” 按键
C. “开”/“关”-按钮	K. 冷却棒*	R. “速度2” 按键
D. 料理搅拌机	L. 多用途切碎杯	S. 点动按键
E. 料理机刀片组件，附带密封圈	M. 多用途切碎杯刀片组件，附带密封圈*	*仅限特定型号
F. 料理机刀片组件机座	N. 多用途切碎杯刀片组件机座	
G. 带加注口的料理搅拌机杯盖	O. 碎冰按键	
H. 量杯		

请参考第2-4页图表

安全建议

- 使用本产品前请去除并扔掉所有包装材料。
- 本产品不可由肢体伤残、感觉或精神障碍以及缺乏相关经验和知识的人员（包括儿童）使用，除非有负责其安全的人员对其进行看管或指导。
- 将本产品及其电源线放在儿童够不到的地方。应对儿童加以看管，确保他们不将本产品作为玩具。
- 儿童不应在没有监管的情况下清洁和维护本产品。
- 本产品只能连接电压和频率均符合铭牌上规定的电源。
- 如果电源线损坏且/或防护外壳损坏，则不要再使用或收拾整理本产品。
- 如果本产品或电源线受损，必须由伊莱克斯或维修代理进行更换，以免发生危险。
- 不得将本产品、电源线或插头浸入水中或任何液体中。
- 不可在桌子或操作台的边缘，也不要再在热气体、火炉、电炉或加热的烤炉附近使用或放置本产品。
- 务必将本产品放置在一个平坦、水平且干燥的台面上。
- 本产品在无人看管时，或在更换附件、清洁及维护前，务必关闭本产品开关并断开其电源。
- 刀片和衬垫非常锋利。有受伤的危险。在更换配件、使用后以及清洗和保养时，应格外小心。
- 本产品接通电源时且/或运转期间，请不要用双手或任何器皿接触刀片或衬垫。
- 不要试图拆掉刀片组件。
- 电器运转时请保持双手和器皿远离，避免人员受伤或电器损坏。
- 从电机机座上拿掉搅拌机时，请确保电器已经关断电源。
- 搅拌罐内没有食物或液体时，请不要操作本产品。

- 盖子没有盖好时，请不要操作本产品。
- 在处理大量食材时不要连续使用本产品超过1分钟。
- 除冰块以外，搅拌罐不得用于搅拌或研磨坚硬和干燥的物体。请使用多用途切割器研磨坚硬和干燥物体（例如坚果、糖果、大米等）。
- 如果高温液体大量流入本产品时一定要小心，瞬间冒出的热气会让高温液体从产品溅出。
- 对于正在沸腾的液体，请勿使用（最高不超过90°C）。
- 不要超过本产品标明的最大装填量。
- 不要使用本产品搅拌油漆。这很危险，会导致爆炸！
- 不得让电源线接触到高温表面，或悬挂在桌子或操作台边缘。
- 请勿使用伊莱克斯不推荐的其他制造商制造的附件或部件，或并非由伊莱克斯出售的附件或部件，这可能会导致人员受伤。
- 本产品仅供室内使用。
- 本产品仅供家庭使用。伊莱克斯对因不当或不正确使用本产品所可能导致的损害不负任何责任。
- 如果本产品开机后您没有选择任何速度或程序，产品将会在5分钟后自动断电。
- 警告：为防止因意外复位热熔断路器造成的危险，本产品不得通过外部开关装置控制，例如计时器，或连接到由公共设施定期打开和关闭的线路。

开始使用

- 首次使用您的电器前：** 拆掉全部包装材料例如外壳、杯子或附件上的塑料、标签或标志。清洗电器和配件，参考指南：“清洁与养护”。
- 准备食材：** 将食材完全清洗干净。切成4到6块并去掉坚硬或较大的果核。去掉水果或蔬菜的表皮。
- 将料理机刀片组件（E）放在料理机刀片组件机座（F）顶部并拧紧料理搅拌杯（D）直至牢固锁定入位。将已经组装好的料理搅拌杯放在果汁料理机机座（A）上并顺时针旋转直至锁定入位。（料理搅拌杯只能装在一个位置上）。锁定后，刀片组件机座上的符号（√）应当与果汁料理机机座上的符号（∧）对齐。将食材放入料理搅拌杯。（不要超过料理搅拌杯标明的最大允许装填量）。
警告！ 始终把密封环放置在料理机刀片周围。仅允许使用伊莱克斯提供的密封环！
- 将盖子上的手柄与搅拌壶的把手对齐以便盖好盖子。插入量杯。**（开始加工后您可以通过加注口添加食材。不要在电器运转时拿掉量杯或盖子。）
警告！ 不要让果汁料理机空转。加工高温液体时，参见第5步。
- 加工高温液体：** 我们建议将高温液体倒入料理搅拌杯前要使其冷却（最高不超过90°C）。先倒入半杯并开始用低速加工。料理搅拌杯的温度会升高——注意保护您的双手，并保持加注口通畅以排出热气。使用前要把盖子放回原处。
- 启动果汁料理机：** 插入电源。按下开/关-按钮（C），按钮会点亮。按下速度1或速度2按钮，选择您想要的加工速度。
- 警告！果汁料理机工作时保持双手和器皿远离本产品。**
警告！ 不要让果汁料理机空转，果汁料理机空转会造成机器过热并损坏本产品。
- 产品已经预先设定了速度（1、2）、定制菜单程序，点动模式。** 所选速度或菜单程序将点亮。果汁料理机将持续运转直至程序执行完毕。按下任意按钮可以手动停止程序。
- 您可以使用点动功能让食材快速混合以达到您期望的粘稠度。** 按下点动按钮（S）进入点动模式。点动和速度按钮开始闪烁。按下1或2可以获得不同的点动速度。

- 10 本产品拥有多种食谱程序。**您可以在碎冰（O）和冰沙（P）之间选择。当程序执行完毕后果汁料理机将自动停止。

使用多用途切碎杯*（*仅限部分型号）

- 11 将多用途切碎杯（J）倒置，使开口朝上。**轻轻地顺时针旋转刀片组件（N），然后移除刀片组件（I）。将所选食材放入多用途切碎杯。不要放入超过半杯。将多用途切碎杯刀片组件（I）以及多用途切碎杯刀片组件机座放在切碎杯开口处并顺时针旋转拧紧切碎杯。
- 将多用途切碎杯正过来放在果汁料理机机座上并顺时针锁定入位。
- 注意：**锁定时，多用途切碎杯刀片组件机座上的符号（V）应当与果汁料理机机座上的符号（^）对齐。
- 警告！刀片非常锋利！**

使用随行杯*（*仅限部分型号）

- 12 将食材放入随行杯（I）。**将料理机刀片（E）装在搅拌杯开口处并通过将其拧在搅拌壶上而拧紧搅拌器刀片组件机座（F）。将随行杯倒置。将组装好的随行杯放在果汁料理机机座（A）上并顺时针旋转直至锁定入位。
- 注意：**锁定后，料理机刀片组件记住上的符号（^）应当与料理机机座上的符号（V）对齐。
- 警告！刀片非常锋利！**



使用冷却棒*（*仅限部分型号）

- 13 冷却棒能让您的冰沙保持较长时间的低温状态。**拧开冷却棒的盖子（K）并注入自来水。拧上冷却棒的盖子并放在冰箱里直至水结成冰。
- 14 将已冻结的冷却棒放入随行杯。**把您刚刚制作好的混合果蔬汁倒入随行杯（I）中，用带把手的直饮瓶盖（J）拧紧。冷却棒可以用洗碗机清洗。

清洁与养护

为防止料理搅拌杯出现裂纹，使用后请用清水冲洗料理搅拌杯。这是为了防止食材中的酸性物质或香精对塑料材质产生腐蚀。冲洗过后，可以放些清洗剂用手洗净，或放在洗碗机中清洗。

不要让制作好的食物（例如汤粥、冰沙、果汁）长时间放在料理搅拌杯中，特别是在加工了酸性食材以后（例如酸橙、柠檬）。但是，如果料理搅拌杯出现细纹也只是表面问题，不会对料理搅拌杯的完整性产生影响。



- 15 把料理搅拌杯放入洗碗机前要用清水完全冲洗。**
- 快速清洗：**将热水倒入料理搅拌杯，加入几滴清洗剂。可以多次按下点动按钮和速度2按钮，让水和清洗剂充分混合。最后，用自来水冲洗料理搅拌杯。
- 16 彻底清洗果汁料理机机座和操作界面：**关闭果汁料理机并拔出电源插头。用湿抹布擦拭果汁料理机机座。
-  **注意！**不要将果汁料理机机座、插头或电线浸入水或任何其他液体。
- 17 彻底清洗料理搅拌杯：注意！刀片组件不可拆卸。**拿掉盖子和量杯。用水和清洗剂冲洗刀片组件。
- 注意！**小心操作，刀片非常锋利！
-  除了果汁料理机机座，其他所有部件都可以用洗碗机清洗。

祝您愉快地使用全新伊莱克斯产品！

食谱

使用多用途切碎杯切割洋葱和大葱等食材时，要切成小于2.5厘米的小段才能达到最佳效果。不建议切割胡萝卜和芹菜等质地粗糙的食材。

最长加工时间	最大容量
1分钟	500毫升

推荐的搅拌速度					
食谱	配料	数量		时间	速度设置
生蔬菜菜泥	胡萝卜	20-80	克	30秒	2 (最大速度)
	土豆	20-80	克		
	洋葱	20-80	克		
	水	60-120	克		
菠萝黄杏冰沙	切成条状的菠萝	200	克		2
	黄杏干	20	克		
	酸奶	250	克		
可用迷你搅拌壶盛放的汤粥	胡萝卜	250	克	≤ 60秒	2
	水	350	毫升		
可用便携瓶盛放的汤粥	胡萝卜	210	克	≤ 60秒	2
	水	290	毫升		
树莓冰沙	冷冻树莓	150	克	程序设置	
	香蕉 (½ 颗)	50	克		
	水	50	克		
	酸奶	250	克		
奶昔	牛奶	100-200	毫升	程序设置	
	香草冰淇淋	100-150	毫升		
	香蕉	¼ - ½	颗		
	巧克力糖浆	30-60	克		
土豆浓汤	土豆	60	克		2
	香蒜	60	克		
	水	180	克		
粘稠的香蒜沙司	成熟的牛油果	2	颗		点动 + 1
	红皮洋葱	1	颗		
	鲜香菜叶	1/4	杯		
	鲜酸橙汁	1或1又1/2	汤匙		
	盐	1	少许		

推荐的搅拌速度					
食谱	配料	数量		时间	速度设置
粘稠的香蒜沙司	鲜紫苏	30	克	≤ 30秒	2
	橄榄油	108	克		
	松子	16	克		
	蒜泥	10	克		
	盐	6	克		
	帕玛森芝士粉	50	克		
	罗马诺芝士粉	30	克		
	黄油	42	克		
鹰嘴豆泥沾酱	灌装鹰嘴豆	200	克		2
	柠檬汁	2	汤匙		
	切碎大蒜瓣	2	颗		
	孜然粉	1	茶匙		
	盐	1	少许		
	芝麻酱（用芝麻种子制作的酱）	1	汤匙		
	水	4	汤匙		
	特级初榨橄榄油	2	汤匙		
辣椒粉	1	茶匙			

多用途切碎杯功能			
多用途切割器每杯最大容量：400毫升		最大干磨时间：30秒	
食材	最大量	时间	速度设置
咖啡	60克	20-30秒	2
海米	50克	开10秒+关3秒（2次）	2
干辣椒	20克	开10秒+关3秒（2次）	2
鲜辣椒	50克	开10秒+关3秒（2次）	2
胡椒籽	100克	开10秒+关3秒（2次）	2
凤尾鱼干	50克	开10秒+关3秒（2次）	2
原料大米	100克	开10秒+关3秒（2次）	2
五香粉	50克	开10秒+关3秒（2次）	2
大蒜	50克	开5秒+关3秒（5次）	2
坚果	80克	5-10秒	2
杏仁	80克	5-10秒	2
洋葱	100克	5-10秒	2
牛肉	100克	5-10秒	2

故障排除

症状	原因	解决方法
果汁料理机不开机	料理搅拌杯/机座没有正确固定。	检查所有部件是否正确入位。 注意！搅拌壶只能放在机座上并且把手朝向用户界面。
	没有按下开/关按钮。	按下果汁料理机上的开/关按钮。果汁料理机开启后控制面板将点亮。
	电机过热。显示屏闪烁。	等待直到本产品已经冷却，并且所有按钮都被点亮。
	插头与电源插座没有正确连接。	检查插头与电源插座的连接，或者尝试换一个电源插座。
	断电。	等待直到恢复供电。
	功能故障。	联系授权服务部门。
电机在操作过程中停转		如果电机停转，立即关掉果汁料理机电源，拔出电器插头，冷却至少10分钟。
	食材体积过大。	将所有坚硬的蔬果或蔬菜切成不大于1.8立方厘米至2.5立方厘米的小块。
	放入了不合适的食材。	该电器用于制作饮品。可以放入水果、蔬菜或类似食材。不要混合加入生面团、土豆泥、肉或类似食材。
如果电器仍无法工作，请联系伊莱克斯客户服务部门。		

弃置

标有  标识的产品均可以回收。您可将产品所有部件放入适当的容器内再回收。为了营造健康宜人的生活环境，请配合并回收废弃的电器用品。

请勿将标有  记号的产品当作家庭垃圾丢弃。回收时，请将产品交由当地回收服务厂商处理，或联络当地政府机构寻求协助。

客户服务

联系客服部门时，请确保您已掌握了以下信息：**型号、PNC、序列号**。此类信息可在铭牌上找到。

由于伊莱克斯(Electrolux)坚持持续开发产品的政策，本手册之中提及的产品规格、颜色、详细信息等等均可能随时更改，恕不另行通知。

伊莱克斯(中国)电器有限公司	
联系地址：上海共和新路1968号大宁国际广8号楼606室	
注册地址：长沙经济技术开发区漓湘路98号和祥科技园	
产品:	伊莱克斯搅拌机(果汁料理机)
型号:	E7CB1-53CW
电源:	220V-50Hz
功率:	900W
产地:	广东 深圳
产品标准:	GB4706.1-2005,GB4706.30-2008

感謝您選用伊萊克斯產品。為確保最佳結果，請始終使用伊萊克斯的原裝配件和零件。它們是專門為您的產品而設計。該產品的設計充分考慮了環境因素。所有塑膠零件都被標記為可回收使用。

說明手冊

手冊內的插圖僅做說明使用，可能與實際產品不同。

首次使用本機時，請詳閱下列說明。

保留此說明書以備日後參考。

零配件圖示

A. 果汁機底座	H. 量杯	O. 碎冰按鍵
B. 防滑底腳	I. 隨行杯*	P. 冰沙按鍵
C. 開/關按鈕	J. 帶把手的直飲蓋子*	Q. 1檔按鍵
D. 迷你攪拌壺	K. 冷卻棒*	R. 2檔按鍵
E. 果汁機刀片組件，附帶密封圈	L. 多功能研磨器玻璃杯*	S. 瞬速按鍵
F. 果汁機刀片組件底座	M. 多功能研磨器刀片*	
G. 帶投料口的迷你攪拌壺蓋子	N. 多功能研磨器刀片底座	*僅限特定型號

請參閱第2-4頁圖示

安全建議

- 使用電器前請去除並扔掉所有包裝材料。
- 本電器設計不適合體格、感官或精神能力不健全，或者是缺少經驗和知識的人士（包括兒童）使用，除非他們已透過負責他們安全的人士獲得有關使用本電器的監督或說明。
- 請將本電器及其電源線放在兒童拿不到的地方。請監督兒童確保他們不會玩弄本電器。
- 若無人監督，不可由兒童執行清潔與使用者保養。
- 本電器僅可連接至電壓及頻率符合定額牌規格的電源供應器。
- 如果電源線損壞且/或防護外殼損壞，則不要再使用或收拾整理本電器。
- 如果本電器或電源線已損壞，則應由伊萊克斯或其服務代理商更換，以避免發生危險。
- 請勿將本電器、電源線或插頭浸入水中或其他液體中。
- 本電器操作時，請勿在桌子或檯面邊緣使用或放置本電器，也不得在熱氣體、瓦斯爐、電爐或加熱的烤爐旁使用或放置本電器。
- 請務必將本電器放置在平坦且平穩的乾燥表面上。
- 本電器無人看管時，以及在更換元件、進行清潔或保養前，請務必關閉本電器並斷其電源。
- 刀片和襯墊非常鋒利。有受傷的危險。在更換配件、使用後以及清洗和保養時，應格外小心。
- 本電器接通電源時且/或運轉期間，請不要用雙手或任何器皿接觸刀片或襯墊。
- 不要試圖拆掉刀片組件。
- 電器運轉時請保持雙手和器皿遠離，避免人員受傷或電器損壞。
- 從電機機座上拿掉攪拌壺時，請確保電器已經斷斷電源。
- 攪拌壺內沒有食物或液體時，請不要操作本電器。

- 蓋子沒有蓋好時，請不要操作本電器。
- 在處理大量食材時，請不要連續使用超過1分鐘。
- 除冰塊以外，攪拌壺不得用於攪拌或研磨堅硬和乾燥的物體。請使用多功能研磨器研磨堅硬和乾燥物體（例如杏仁、糖果、米粒等）。
- 如果高溫液體大量流入本電器時一定要小心，瞬間冒出的熱氣會讓高溫液體從電器濺出。
- 對於正在沸騰的液體，請勿使用（最高不超過90°C）。
- 不要超過本電器標明的最大裝載量。
- 不要使用本電器攪拌油漆。這很危險，會導致爆炸！
- 請勿讓電源線接觸灼熱表面，或懸掛在桌子或檯面邊緣。
- 請勿使用伊萊克斯不建議使用的、由其他製造商製造的配件或零件，請勿使用非由伊萊克斯出售的配件或零件，這可能會造成人員傷害。
- 本電器僅供室內使用。
- 本電器僅供家庭使用。任何不當使用所導致的損壞，伊萊克斯將不負任何責任。
- 如果本電器開機後您沒有選擇任何速度或程式，電器將會在5分鐘後自動斷電。
- 警告：為防止因意外復位熱熔斷路器造成的危險，本產品不得透過外部開關裝置控制，例如計時器，或連接到由公共設施定期打開和關閉的線路。

入門

- 1 首次使用本產品前：**拆掉全部包裝材料例如外殼、杯子或附件上的塑膠、貼紙或標籤。清洗本產品和配件，參考指南：“清潔與保養”。
- 2 準備食材：**將食材完全清洗乾淨。切成4到6塊並去掉堅硬或較大的果核。去掉水果或蔬菜的表皮。
- 3 將果汁機刀片組件（E）放在果汁機刀片組件底座（F）頂部並擰緊攪拌壺（D）直至牢固鎖定入位。將已經組裝好的攪拌壺放在果汁機底座（A）上並順時針旋轉直至鎖定入位。（攪拌壺只能裝在一個位置上）。鎖定後，刀片零件底座上的符號（✓）應當與果汁機底座上的符號（∧）對齊。將食材放入攪拌壺。（不要超過攪拌壺標明的最大允許裝填量）。**

警告！始終把密封環放置在果汁機刀片周圍。僅允許使用伊萊克斯提供的密封環！
- 4 將蓋子與攪拌壺的把手對齊以便蓋好蓋子。將量杯放置上去。（開始運作後您可以透過投料口添加食材。不要在電器運轉時拿掉量杯或蓋子。）**

警告！不要讓果汁機空轉。加工高溫液體時，參見第5步。
- 5 攪拌高溫液體：**我們建議將高溫液體倒入攪拌壺前要使其冷卻（最高不超過90°C）。先倒入半壺並開始用低速攪拌。攪拌壺的溫度會升高——注意保護您的雙手，並保持投料口通暢以排出熱氣。使用前要把蓋子放回原處。
- 6 啟動果汁機：**插入電源。按下開/關-按鈕（C），按鈕會亮起。按下速度1或速度2按鈕，選擇您想要的攪拌速度。
- 7 警告！攪拌時保持雙手和器皿遠離攪拌壺。**

警告！不要讓果汁機空轉，果汁機空轉會造成機器過熱並損壞本電器。
- 8 您的選擇包含速度（1、2）、預設食譜程式，及瞬速模式。**所選速度或食譜程式將亮起。果汁機將持續運轉直至程式執行完畢。按下任意按鈕可以手動停止程式。

- 9 您可以使用瞬速功能讓食材快速混合以達到您期望的黏稠度。按下瞬速按鈕 (V) 進入瞬速模式。瞬速和速度按鈕開始閃爍。按下1、2可以獲得不同的瞬速速度。
- 10 本產品擁有多種食譜製作程式。您可以在碎冰 (O) 和冰沙 (P) 之間選擇。當程式執行完畢後果汁機將自動停止。

使用多功能研磨器* (*僅限部分型號)

- 11 將多功能研磨器 (J) 倒置，使開口朝上。輕輕地順時針擰開刀片底座 (N)，然後移除刀片零件 (M)。將所選食材放入多功能研磨器玻璃杯。不要放入超過半壺。將多功能研磨器刀片組件 (M) 以及多功能研磨器刀片組件底座放在玻璃杯開口處並順時針旋轉擰緊玻璃杯。將多功能研磨器轉過來放在果汁機底座上並順時針鎖定入位。
注意：鎖定時，多功能研磨器刀片零件底座上的符號 (✓) 應當與果汁機底座上的符號 (Λ) 對齊。
警告！刀片非常鋒利！

使用隨行杯* (*僅限部分型號)

- 12 將食材放入隨行杯 (I)。將果汁機刀片組 (F) 放置在隨行杯開口處並將其擰緊。將組裝好的隨行杯倒置在果汁機底座 (A) 上，並順時針旋轉直至鎖定入位。
注意：鎖定後，果汁機刀片零件標記的符號 (Λ) 應當與果汁機底座上的符合 (✓) 對齊。
警告！刀片非常鋒利！



使用冷卻棒* (*僅限部分型號)

- 13 冰沙冷卻棒能讓您的冰沙保持較長時間的低溫狀態。擰開冷卻棒的蓋子 (K) 並注入自來水。擰上冷卻棒的蓋子並放在冰箱裡直至水結成冰。
- 14 將已凍結的冷卻棒放入隨行杯。把您剛剛製作好的綜合蔬果汁倒入隨行杯 (K) 中，用帶把手的直飲瓶蓋 (L) 擰緊。冷卻棒可以用洗碗機清洗。

清潔與保養

為防止攪拌壺出現裂紋，使用後請用清水沖洗攪拌壺。這是為了防止食材中的酸性物質或香精對塑膠材質產生腐蝕。沖洗過後，可以放些清潔劑用手洗淨，或放在洗碗機中清洗。

不要讓製作好的食物 (例如湯料、冰沙、果汁) 長時間放在攪拌壺中，特別是在加工了酸性食材以後 (例如酸橙、檸檬)。但是，如果攪拌壺出現裂紋也只是表面問題，不會對攪拌壺的完整性產生影響。



- 15 把攪拌壺放入洗碗機前要用清水完全沖洗。
快速清洗：將熱水倒入攪拌壺，加入幾滴清潔劑。可以多次按下瞬速按鈕和速度2按鈕，讓水和清潔劑充分混合。最後，用自來水沖洗攪拌壺。
- 16 **徹底清洗果汁機底座和操作介面：**關閉果汁機並拔下電源插頭。用濕抹布擦拭果汁機底座。
 **注意！**不要將果汁機底座、插頭或電線浸入水或任何其他液體。
- 17 **徹底清洗攪拌壺：****注意！**刀片組件不可拆卸。拿掉蓋子和量杯。用水和清潔劑沖洗刀片組件。
注意！小心操作，刀片非常鋒利！
 配件除了果汁機底座，其他所有配件都可以用洗碗機清洗。

祝您愉快地使用全新伊萊克斯產品！

食譜

使用多功能研磨器切割洋蔥和大蔥等食材時，要切成小於2.5公分的小段才能達到最佳效果。不建議切割紅蘿蔔和芹菜等質地粗糙的食材。

最長加工時間	最大容量
1分鐘	500毫升

建議的攪拌速度					
食譜	配料	數量		時間	速度
沙拉菜泥	紅蘿蔔	20-80	克	30秒	2 (最快速度)
	馬鈴薯	20-80	克		
	洋蔥	20-80	克		
	水	60-120	克		
鳳梨桃子果昔	切成條狀的鳳梨	200	克		2
	乾桃子	20	克		
	優酪乳	250	克		
可用迷你攪拌壺盛放的湯料	紅蘿蔔	250	克	≤ 60秒	2
	水	350	毫升		
可用隨行杯盛放的湯料	紅蘿蔔	210	克	≤ 60秒	2
	水	290	毫升		
覆盆子果昔	冷凍覆盆子	150	克	程式設置	
	香蕉 (1/2顆)	50	克		
	水	50	克		
	優酪乳	250	克		
奶昔	牛奶	100-200	毫升	程式設置	
	香草霜淇淋	100-150	毫升		
	香蕉	1/4 - 1/2	顆		
	巧克力糖漿	30-60	克		
馬鈴薯濃湯	馬鈴薯	60	克		2
	香蒜	60	克		
	水	180	克		
粘稠的香蒜醬	成熟的酪梨	2	顆		瞬速 + 1
	紅皮洋蔥	1	顆		
	新鮮香菜葉	1/4	杯		
	新鮮酸橙汁	1及1又1/2	湯匙		
	鹽巴	1	少許		
粘稠的香蒜沙司	新鮮紫蘇	30	克	≤ 30秒	2
	橄欖油	108	克		
	松子	16	克		
	蒜泥	10	克		
	鹽巴	6	克		
	帕瑪森起司粉	50	克		
	羅馬諾起司粉	30	克		
	牛油	42	克		

建議的攪拌速度

食譜	配料	數量		時間	速度
鷹嘴豆泥沾醬	罐裝鷹嘴豆	200	克		2
	檸檬汁	2	湯匙		
	切碎大蒜瓣	2	顆		
	孜然粉	1	茶匙		
	鹽巴	1	少許		
	芝麻醬 (用芝麻種子製作的醬)	1	湯匙		
	水	4	湯匙		
	特級初榨橄欖油	2	湯匙		
	辣椒粉	1	茶匙		

多功能研磨器功能

多功能研磨器每杯最大容量：400毫升		最大研磨時間：30秒	
食材	最大量	時間	速度
咖啡	60 克	20-30秒	2
乾蝦米	50 克	開10秒+關3秒 (2次)	2
乾辣椒	20 克	開10秒+關3秒 (2次)	2
新鮮辣椒	50 克	開10秒+關3秒 (2次)	2
胡椒籽	100 克	開10秒+關3秒 (2次)	2
乾鯷魚	50 克	開10秒+關3秒 (2次)	2
糙米	100 克	開10秒+關3秒 (2次)	2
五香粉	50 克	開10秒+關3秒 (2次)	2
大蒜	50 克	開5秒+關3秒 (2次)	2
堅果	80 克	5-10秒	2
杏仁	80 克	5-10秒	2
洋蔥	100 克	5-10秒	2
牛肉	100 克	5-10秒	2

故障排除

症狀	原因	解決方法
果汁機尚未開機	攪拌壺/底座沒有正確固定。	檢查所有配件是否正確入位。注意！攪拌壺只能放在底座上並且把手朝向使用者介面。
	沒有按下開/關按鈕。	按下果汁機上的開/關按鈕。果汁機開啟後控制面板將會亮起。
	馬達過熱。顯示面板閃爍。	讓本電器冷卻至少X分鐘，然後所有按鈕將重新亮起。
	插頭與電源插座沒有正確連接。	檢查插頭與電源插座的連接，或者嘗試換一個電源插座。
	斷電。	等待直到恢復供電。
	功能故障。	聯繫授權服務部門。
馬達在操作過程中停轉		如果本電器停轉，立即關掉果汁機電源，拔出本電器插頭，冷卻至少10分鐘。
	食材體積過大。	將所有堅硬的蔬果或蔬菜切成小於1.8平方公分至2.5平方公分的小塊。
	放入了不合適的食材。	本電器用於製作飲品。可以放入水果、蔬菜或類似食材。但請不要混合加入生麵團、馬鈴薯泥、肉或類似食材。
如果本電器仍無法運作，請聯繫伊萊克斯客戶服務部門。		

棄置

標有  標識的產品均可以回收。您可將產品所有附件放入適當的容器內再回收。為了保護環境並營造更健康宜人的生活環境，請配合並回收廢棄的電器用品。



請勿將標有  記號的產品當作家庭垃圾丟棄。回收時，請將產品交由當地回收服務廠商處理，或聯絡當地政府機構尋求協助。

客戶服務

聯繫客服部門時，請確保您已掌握了以下資訊：**型號、PNC、序號**。此類資訊可在產品機身標籤上找到。

由於Electrolux堅持永續開發的政策，本手冊之中提及的產品規格、顏色、詳細資訊等等均可能隨時更改，恕不另行通知。

有鑒於世界各國對綠色環保意識的重視，伊萊克斯依循RoHS「危害性限制物質指令」誠實標示產品化學物質含量，關於本產品的RoHS聲明書，請上伊萊克斯官網 -->「支援服務」-->「RoHS聲明書」，依產品類別及型號檢索。
<http://www.electrolux.com.tw/Support/Customer-Care/>

ELECTROLUX 제품을 선택해주셔서 감사합니다. 최선의 사용 결과를 얻을 수 있도록 언제나 정품 ELECTROLUX 액세서리와 예비 부품을 이용하십시오. 본 제품은 환경을 염두에 두고 설계되었습니다. 모든 플라스틱 부품은 재활용이 가능한 것으로 표시되어 있습니다.

사용 설명서

사용설명서 내 이미지는 실제 제품 이미지와 다소 차이가 있을 수 있습니다.
제품을 처음 사용하기 전에 모든 지시 사항을 주의 깊게 읽으십시오.
나중에 참고할 수 있도록 이 설명서를 보관해 두시기 바랍니다.

구성 부품

A. 블렌더 본체	I. 테이크 아웃 보틀*	P. 스무디 버튼
B. 미끄럼 방지 발	J. 테이크 아웃 보틀 뚜껑*	Q. 펄스 버튼
C. 전원버튼	K. 냉각 스틱*(한국 모델에는 해당 없음)	
D. 저그	L. 다목적 분쇄기 통*	
E. 블렌더 칼날	M. 다목적 분쇄기 칼날*	*특정 모델만 해당
F. 블렌더 칼날 본체	N. 다목적 분쇄기 칼날 본체*	(다목적 분쇄기는 E7CB1-8XXX만 해당)
G. 저그 뚜껑	O. 얼음 분쇄 버튼	
H. 계량컵		

2-4페이지 그림

안전 주의 사항

- 장치를 사용하기 전에 포장재를 모두 벗기고 안전하게 폐기하십시오.
- 이 제품은 안전에 관하여 책임이 있는 사람이 제품 사용에 관한 감독 또는 지시를 하는 경우를 제외하면 신체, 감각 또는 지적 능력이 낮거나 경험과 지식이 부족한 사람(어린이 포함)은 사용할 수 없습니다.
- 제품과 전원 코드를 어린이의 손이 닿지 않는 곳에 두십시오. 어린이가 제품을 가지고 놀지 못하도록 해야 합니다.
- 감독 없이 어린이가 청소 및 사용자 준비를 수행해서는 안됩니다.
- 제품은 전압 및 주파수가 본 제품에 표시된 규격과 일치하는 전원 장치에만 연결할 수 있습니다.
- 전원 코드 손상 및/또는 하우징 손상이 발생한 경우에는 장치를 사용하거나 들어올리지 마십시오.
- 제품 또는 전원 코드가 손상된 경우 위험 방지를 위해 Electrolux 또는 서비스 대리점을 통해 교체해야 합니다.
- 물이나 액체에 제품, 전원 코드 또는 플러그를 담그지 마십시오.
- 제품을 탁자나 카운터 가장자리, 가스레인지, 스토브, 전기 버너 및 가열된 오븐 근처에 두거나 이런 장소에서 사용하지 마십시오.
- 항상 제품을 평평하고 건조한 곳에 두십시오.
- 자리를 비울 때 또는 액세서리를 변경하거나 청소 또는 유지보수 할 때는 항상 제품을 끄고 전원에서 분리하십시오.
- 칼날과 부속품이 매우 날카롭습니다. 상해 위험이 있습니다. 부속품 교체 시, 사용 후 청소 및 유지관리 시 주의하십시오.
- 장치 플러그가 연결된 상태 또는 작동중인 상태에서는 손이나 기구로 칼날이나 부속품에 접촉하지 마십시오.
- 칼날을 분리하려 하지 마십시오.
- 사람의 심각한 상해나 장치의 손상 위험을 방지할 수 있도록 손과 기구를 장치에서 멀리 두십시오.
- 저그를 본체에서 분리하기 전에 본체 전원을 끈는지 확인하십시오.
- 음식이나 액체가 저그에 없는 상태에서 장치를 작동하지 마십시오.
- 뚜껑 없이 장치를 작동하지 마십시오.
- 많은 양을 처리할 때 장치를 1분 넘게 연속으로 작동하지 마십시오.
- 저그는 각얼음을 제외한 단단하고 마른 재료를 갈거나 혼합할 수 없습니다. 단단하고 마른 재료를 갈 때 (예: 견과류, 사탕, 쌀 등...) 다목적 분쇄기를 이용하십시오.

- 뜨거운 액체를 장치에 넣으면 갑자기 증기가 발생하여 튀어나올 수 있습니다.
- 끓는 물을 이용하지 마십시오(최고 90°C).
- 제품에 표시된 최대 주입 용량을 초과하지 마십시오.
- 이 장치로 페인트를 혼합하지 마십시오. 위험하며 폭발이 발생할 수 있습니다!
- 전원 코드가 뜨거운 면에 닿거나 탁자 또는 카운터 모서리에 걸려 있지 않게 하십시오.
- Electrolux에서 권장하거나 판매하지 않는 타 제조업체에서 만든 액세서리나 부품은 사용하지 마십시오. 부상위험이 있습니다.
- 이 제품은 실내 전용입니다.
- 이 제품은 가정용으로만 만들어진 것입니다. Electrolux는 부적절하거나 부정확한 사용으로 인해 발생 가능한 손상에 대해 책임을 지지 않습니다.
- 속도나 프로그램을 이용하지 않고 장치를 놔둘 경우 5분 후에 자동으로 꺼집니다.
- 주의: 우발적인 열 차단 리셋 위험을 방지하기 위해 본 장치는 타이머와 같은 외부 스위치 장치로 연결해서는 안되며 주기적으로 전원이 켜지고 꺼지는 회로에 연결해서는 안됩니다.

시작하기

- 1 장치물 처음 사용하시기 전에:** 플라스틱이나 스티커, 태그 등 하우징이나 불, 부착물에 붙어 있는 모든 포장재를 떼어내십시오. “세척 및 관리”를 참조하여 장치와 액세서리를 청소하십시오.
- 2 재료를 준비합니다.** 재료를 잘 씻으십시오. 재료를 4 조각에서 6 조각으로 자르고 딱딱하거나 큰 씨를 제거합니다. 과일이나 야채에서 두꺼운 껍질을 벗겨냅니다.
- 3 블렌더 칼날(E)을 블렌더 칼날 본체(F)에 장착합니다.**(플라스틱 부분을 위에서 아래로 눌러 딸깍 소리가 날 때까지 누르면 고정됩니다.) 그런 다음, 제 자리에 단단히 고정될 때까지 저그(D)를 조입니다. 조립된 저그를 블렌더 본체(A)에 놓습니다. 저그 손잡이의 아래쪽 원편에 있는 연결 요철 나사가 블렌더의 연결 부위에 오도록 올려놓고, 딸깍 소리가 날 때까지 시계 방향으로 돌립니다. 저그가 고정되면 저그 손잡이 왼쪽에 V 표시와 블렌더 본체A 표시가 일직선상에 옵니다. 재료를 저그에 넣습니다. (저그에 표시된 최대 높이를 초과해서는 안됩니다.)
주의 항상 실링 링을 블렌더 칼날 주변에 끼운 후 사용하십시오.
- 4 계량컵을 뚜껑에 끼운 후, 저그 위에 뚜껑을 덮습니다.** 저그 뚜껑 구멍을 통해 재료를 추가할 수 있습니다. 제품이 작동하는 중에는 계량컵이나 뚜껑을 분리하지 마십시오.
주의 블렌더를 빈 상태로 작동하지 마십시오. 뜨거운 액체를 처리할 경우 5 단계를 참조하십시오.
- 5 뜨거운 액체 처리:** 저그에 뜨거운 재료를 넣기 전에 먼저 식힐 것을 권장합니다. (최고 90°C) 저그의 절반만 채우고 저속으로 작동을 시작합니다. 블렌더 저그 온도가 매우 높아질 수 있습니다. 손을 보호하도록 주의하고 뚜껑 구멍을 통해 증기를 빼내도록 하십시오. 사용 전에는 항상 뚜껑을 교체하십시오.
- 6 블렌더 작동을 시작합니다.** 플러그를 주전원에 연결합니다. 전원 버튼(C)을 누르면 버튼에 불이 들어옵니다. 속도 1 또는 속도 2 버튼을 눌러 원하는 작동 속도를 선택합니다.
- 7 주의: 제품 작동시 손과 식기는 블렌더 저그 밖에 두십시오.**
주의 블렌더는 빈 상태에서 작동하지 마십시오. 블렌더를 빈 상태로 작동하면 과열이 발생하고 제품이 손상될 수 있습니다.
- 8 속도(1,2), 레시피 프로그램, 펄스 모드를 선택할 수 있습니다.** 선택된 속도나 레시피 프로그램에 불이 들어옵니다. 블렌더는 미리 프로그래밍된 시간이 완료될 때까지 작동합니다. 프로그램을 수동으로 멈추려면 아무 버튼이나 누릅니다.
- 9 재료를 빠르게 혼합하여 블렌딩하는 펄스 기능으로 원하는 식감을 일관성있게 만들 수 있습니다.** 펄스 버튼(S)을 눌러 펄스 모드로 들어갑니다. 펄스와 속도 버튼이 깜박이기 시작합니다. 1, 2를 누르면 서로 다른 속도로 펄스가 작동합니다.
- 10 제품은 다양한 레시피 프로그램이 함께 제공됩니다.** 얼음 분쇄(O)와 스무디(P)를 선택할 수 있습니다. 블렌더는 프로그램이 준비되면 자동으로 멈춥니다.

다목적 분쇄기 사용* (*특정 모델만, E7CB1-8XXX에만 해당)

- 11 칼날이 아래쪽을 향하도록 다목적 분쇄기 통(L)을 놓습니다.** 다목적 분쇄기 칼날 본체(N)를 반시계방향으로 돌려 본체와 칼날을 통으로부터 분리합니다. 다목적 분쇄기통을 원하는 재료로 채웁니다. 절반 이상으로 채우지 마십시오. 다목적 분쇄기 칼날과 본체를 통위에 올리고 시계 방향으로 돌려 고정합니다. 칼날이 위를 향하도록 다목적 분쇄기를 놓은 후, 시계방향으로 돌려 블렌더 본체에 고정합니다.
알림: 잠금 상태에서는 다목적 분쇄기통의 기호(V)가 블렌더 본체 기호(A)와 정렬되어야 합니다.
주의: 칼날이 매우 날카롭습니다!

테이크 아웃 보틀* (*특정 모델만)

- 12 재료를 휴대용 병(I)에 넣습니다.** 날 어셈블리를 위치시킵니다. (E)을 주전자의 열린 쪽에 넣고 블렌더 날 어셈블리 베이스(F)를 주전자에 돌려서 조입니다. 휴대용 병을 뒤집습니다. 조립된 휴대용 병을 블렌더 베이스(A)에 두고 시계 방향으로 돌려 딸깍 소리를 내며 고정될 때까지 시계 방향으로 돌립니다.
주: 잠금 상태에서는 블렌더 날 어셈블리 베이스의 기호(A)가 블렌더 베이스의 기호(V)와 정렬되어야 합니다.
주의: 날이 매우 날카롭습니다!

냉각 스틱 사용* (*특정 모델만, 한국 모델에는 해당 없음)

- 13 냉각 스틱은 스무디를 오래 시원하게 유지합니다.** 냉각 스틱의 캡(K)을 풀고 물을 채웁니다. 냉각 스틱에 캡을 다시 조이고 물이 얼 때까지 냉장고에 넣습니다.
14 언 냉각 스틱을 테이크아웃 병에 넣습니다. 신선하게 준비한 블렌드를 휴대용 병(I)에 넣고 휴대 손잡이가 달린음료 뚜껑(J)을 잠급니다. 냉각 스틱은 식기세척기로 세척할 수 있습니다.



세척 및 관리

저그에 균열이 생기지 않도록 사용 후에는 항상 바로 깨끗한 물로 세척하십시오. 세척을 통해 재료의 산이나 오일이 플라스틱을 손상시키지 않도록 할 수 있습니다. 저그를 세제를 이용하여 세척하거나 식기세척기에 넣을 수 있습니다.

특히 산성 재료(예: 라임, 레몬)를 블렌드한 경우에는 준비된 음식(예: 수프, 스무디, 주스)을 저그에 오래 두지 마십시오.

식기세척기에 넣기 전에는 항상 깨끗한 물로 저그를 잘 씻어주십시오

균열이 생기더라도 그 영향은 외관에만 미치며 저그의 상태에는 영향을 주지 않습니다.



- 15 빠른 세척:** 저그에 따뜻한 물을 넣고 세제를 몇 방울 추가합니다. 펄스 버튼을 누르고 속도 2 버튼을 몇 번 눌러 물과 세제를 혼합합니다. 마지막으로 흐르는 물에 저그를 헹굽니다.
- 16 블렌더 본체와 인터페이스를 잘 세척합니다.** 블렌더를 끄고 전원 코드를 뽑니다. 젖은 천으로 블렌더 본체를 닦아줍니다.
 **주의:** 블렌더 본체나 플러그, 코드를 물 또는 다른 액체에 담그지 마십시오.
- 17 저그를 깨끗이 세척하십시오. 주의: 칼날은 분리되지 않습니다.** 뚜껑과 계량컵을 분리합니다. 칼날을 물과 세제로 세척합니다.
주의: 칼날이 매우 날카로우므로 주의하십시오!
 블렌더 본체를 제외한 모든 부품은 식기세척기에 안전하게 사용할 수 있습니다.

새로운 Electrolux 제품을 즐기십시오!

조리법

다목적 분쇄기를 이용하여 가장 좋은 결과를 낼 수 있도록 양파와 샐러드와 같은 재료를 분쇄할 때 재료를 2.5cm 이하의 정육면체로 잘라주십시오. 당근과 셀러리 등 질감이 거친 재료는 분쇄를 권장하지 않습니다.

최대 처리 시간	최대 용량
1분	500ml

권장 블렌딩 속도					
조리법	재료	양		시간	속도
야채 푸레 만들기	당근	20~80	g	30 s	2 (최대 속도)
	감자	20~80	g		
	양파	20~80	g		
	물	60~120	g		
파인애플 샐구 스무디	파인애플 슬라이스	200	g		2
	말린 샐구	20	g		
	요거트	250	g		
당근 수프	당근	250	g	≤ 60 s	2
	물	350	ml		
당근 수프 (테이크 아웃 보틀용)	당근	210	g	≤ 60 s	2
	물	290	ml		
라즈베리 스무디	냉동 라즈베리	150	g	프로그램 설정	
	바나나(½ 조각)	50	g		
	물	50	g		
	요거트	250	g		
밀크셰이크	우유	100-200	ml	프로그램 설정	
	바닐라 아이스크림	100-150	ml		
	바나나	¼ - ½	개		
	초콜렛 시럽	30-60	g		
감자 부추 수프	감자	60	g		2
	부추	60	g		
	물	180	g		
과카몰리	잘 익은 아보카도	2	개		순간작동+1
	적양파	1	개		
	신선한 고수 잎	1/4	컵		
	신선한 라임 주스	1 및 1 1/2	식탁용 스푼		
	소금	1	꼬집		
페스토	신선한 바실	30	g	≤ 30 s	2
	올리브유	108	g		
	잣	16	g		
	다진 양파	10	g		
	소금	6	g		
	강판에 간 파마산 치즈	50	g		
	강판에 간 로마노 치즈	30	g		
	버터	42	g		

권장 블렌딩 속도					
조리법	재료	양		시간	속도
세미 스무스 후무스	캔 병아리콩	200	g		2
	레몬 주스	2	식탁용 스푼		
	마늘 쪽, 분쇄	2	개		
	간 쿠민	1	티스푼		
	소금	1	꼬집		
	타히니(참깨 페이스트)	1	식탁용 스푼		
	물	4	식탁용 스푼		
	엑스트라 버진 올리브유	2	식탁용 스푼		
	파프리카	1	티스푼		

다목적 분쇄기 기능			
다목적 분쇄기 컵의 최대 부피: 400ml		최대 건조 분쇄 시간: 30 초	
재료	최대 분량	시간	속도
커피	60 g	20-30 초	2
건새우	50 g	10 초 켜기 + 3초 끄기(2회)	2
마른고추	20 g	10 초 켜기 + 3초 끄기(2회)	2
푼고추	50 g	10 초 켜기 + 3초 끄기(2회)	2
후추알	100 g	10 초 켜기 + 3초 끄기(2회)	2
마른멸치	50 g	10 초 켜기 + 3초 끄기(2회)	2
생쌀	100 g	10 초 켜기 + 3초 끄기(2회)	2
오향	50 g	10 초 켜기 + 3초 끄기(2회)	2
마늘	50 g	5초 켜기 + 3초 끄기(5회)	2
견과류	80 g	5-10 초	2
아몬드	80 g	5-10 초	2
양파	100 g	5-10 초	2
소고기	100 g	5-10 초	2

문제 해결

증상	가능한 원인	해법
블렌더가 켜지지 않습니다.	저그/본체가 올바르게 고정되지 않았습니다.	모든 부품이 올바른 위치에 있는지 확인하십시오. 주의 저그 손잡이가 정면을 향한 상태에서만 사용할 수 있습니다.
	전원버튼을 누를 수 없습니다.	전원버튼을 눌러 블렌더를 켭니다. 블렌더가 켜지면 제어판에 불이 들어옵니다.
	모터가 과열되었습니다. 디스플레이가 깜박입니다.	제품이 냉각되고 모든 버튼에 불이 들어올 때까지 기다리십시오.
	플러그가 콘센트에 올바르게 연결되지 않았습니다.	플러그와 콘센트 연결을 확인하거나 다른 콘센트를 이용해보십시오.
	정전	정전이 끝날 때까지 기다려주십시오.
	기능 문제	공식 서비스에 문의하십시오.
작동 중에 모터가 멈춥니다.		모터가 멈추면 블렌더를 즉시 끄고 장치 플러그를 뺀 다음 10분 이상 냉각시키십시오.
	재료가 너무 큼니다.	단단한 과일과 야채는 1.8cm ² 에서 2.5cm ² 이하의 조각으로 자르십시오.
	잘못된 재료	장치의 용도는 음료를 만드는 것입니다. 과일이나 야채 등을 넣으십시오. 도우나 으갠 감자, 육류 등의 재료는 섞지 마십시오.
장치가 계속 작동을 하지 않으면 Electrolux 고객 서비스에 문의하십시오.		

폐기 처분



기호가 있는 재질은 재활용하십시오. 포장재는 분리 수거하여 재활용하십시오.
환경 및 건강을 보호하고 전기 및 전자 제품 폐기물을 재활용하도록 도움을 부탁드립니다.



기호가 있는 제품은 가정용 쓰레기와 함께 폐기하지 마십시오. 제품을 현지의 재활용 시설에 돌려주거나 담당 기관에 연락하십시오.

고객 관리 및 서비스

서비스 센터에 연락할 때는 **모델, PNC, 일련번호**를 준비해 주십시오. 이 정보는 제품에 부착된 라벨에서 볼 수 있습니다.

지속적인 제품 개발을 위한 *Electrolux*의 정책으로 인해 당사 제품의 사양, 색상 및 세부사항 그리고 본 설명서에서 언급된 내용은 **통보 없이 변경될 수 있습니다.**

Terima kasih telah memilih produk dari Electrolux. Untuk memastikan hasil terbaik, selalu gunakan aksesori dan suku cadang asli Electrolux yang telah dirancang khusus untuk produk Anda. Produk ini ramah lingkungan. Semua komponen plastik memiliki tanda dapat didaur ulang.

BUKU PETUNJUK

Grafik dan gambar di dalam buku petunjuk ini hanya sebagai ilustrasi dan produk dalam gambar bisa berbeda dengan aslinya.

Bacalah semua petunjuk dengan cermat sebelum menggunakan perabot untuk pertama kalinya. Simpanlah buku petunjuk ini untuk acuan di masa mendatang.

KOMPONEN

- | | | |
|--|--|--------------------------------|
| A. Bodi blender | H. Cangkir ukur | O. Tombol penghancur es |
| B. Kaki berpenyungkup | I. Botol minum* | P. Tombol smoothie |
| C. Tombol ON/OFF | J. Tutup botol dengan gagang bertali* | Q. Tombol 'kecepatan 1' |
| D. Gelas mini | K. Stik pendingin* | R. Tombol 'kecepatan 2' |
| E. Pisau blender dengan ring perapat | L. Toples serbaguna* | S. Tombol PULSE |
| F. Dudukan pisau blender | M. Pisau serbaguna dengan ring perapat* | |
| G. Tutup gelas mini dengan lubang tuang | N. Dudukan untuk pisau serbaguna* | *Hanya model tertentu |

GAMBAR PADA HALAMAN 2-4

ANJURAN KESELAMATAN

- Kelupas dan buang semua bahan pembungkus sebelum menggunakan perabot ini.
- Perabot ini tidak dimaksudkan untuk digunakan oleh orang (termasuk anak-anak) dengan kemampuan fisik, indera, atau mental yang kurang, atau kurang pengalaman dan pengetahuan, kecuali jika mereka telah diberi petunjuk atau diawasi dalam menggunakan perabot ini oleh orang yang bertanggung jawab atas keselamatan mereka.
- Jauhkan perabot dan kabel dayanya dari jangkauan anak-anak. Anak-anak harus diawasi untuk memastikan bahwa mereka tidak bermain-main dengan perabot ini.
- Pembersihan dan perawatan oleh pengguna tidak boleh dilakukan oleh anak-anak tanpa pengawasan.
- Perabot ini hanya boleh dihubungkan ke catu daya yang tegangan dan frekuensinya sesuai dengan spesifikasi pada pelat rating-nya.
- Jangan sekali-kali menggunakan atau mengangkat perabot apabila terdapat kerusakan pada kabel dan/atau kerangka bodi.
- Jika perabot atau kabel dayanya rusak, penggantianannya harus dilakukan oleh Electrolux atau agen servisnya untuk menghindari bahaya.
- Jangan merendam perabot, kabel dayanya, atau stekernya di dalam air atau cairan apa pun.
- Jangan menggunakan atau menempatkan perabot di dekat pinggir meja atau konter, di dekat kompor gas, kompor minyak, kompor listrik, atau oven yang panas.
- Selalu tempatkan perabot di atas permukaan yang datar, rata, dan kering.
- Selalu matikan perabot dan lepaskan dari catu daya jika akan ditinggal tanpa diawasi dan sebelum mengganti aksesori, membersihkan, atau merawatnya.
- Mata pisau dan sisipan sangat tajam. Dapat menyebabkan cedera. Berhati-hatilah saat mengganti aksesori, setelah menggunakan, dan selama membersihkan dan melakukan perawatan.
- Jangan sekali-kali menyentuh mata pisau dengan tangan atau dengan alat lain saat perabot tersambung ke sumber listrik dan/atau selama sedang dioperasikan.

- Jangan berusaha membongkar komponen mata pisau.
- Jauhkan tangan atau alat lainnya saat perabot beroperasi untuk menghindari risiko cedera parah pada pengguna atau kerusakan pada perabot
- Pastikan perabot dalam keadaan mati sebelum mengangkat gelas dari bodi motor.
- Jangan mengoperasikan perabot tanpa bahan makanan atau cairan di dalam gelas.
- Jangan sekali-kali mengoperasikan perabot jika tutup tidak terpasang.
- Jangan mengoperasikan perabot terus-menerus selama lebih dari 1 menit dengan muatan berat.
- Gelas tidak dapat digunakan untuk memblender bahan makanan yang keras dan kering, kecuali es batu. Gunakan pisau serbaguna untuk menggiling bahan makanan yang keras dan kering (seperti kacang, permen, beras, dsb...)
- Berhati-hatilah saat menuang cairan panas ke dalam gelas karena dapat tertiup yang disebabkan oleh penguapan seketika.
- Jangan sekali-kali memproses cairan mendidih (maks 90°C).
- Jangan mengisi melebihi batas volume maksimal yang tertera pada perabot
- Jangan menggunakan perabot untuk mengaduk cat. Bahaya, dapat menyebabkan ledakan!
- Jangan biarkan kabel listriknya bersentuhan dengan permukaan panas atau tergantung di tepi meja atau konter.
- Jangan sekali-kali menggunakan aksesoris atau komponen yang dibuat oleh produsen lain yang tidak disarankan atau dijual oleh Electrolux karena dapat menimbulkan risiko cedera.
- Perabot ini hanya untuk penggunaan dalam ruangan.
- Perabot ini dimaksudkan hanya untuk penggunaan dalam rumah tangga. Electrolux tidak bertanggung jawab atas kemungkinan kerusakan yang disebabkan oleh penggunaan yang tidak sesuai atau tidak benar.
- Jika perabot dibiarkan tanpa menekan tombol program atau kecepatan, perabot akan otomatis mati setelah 5 menit
- PERHATIAN: Untuk menghindari bahaya karena pemutusan termal tiba-tiba, perabot tidak boleh digunakan bersama dengan perangkat saklar eksternal, seperti timer, atau disambungkan ke sirkuit yang secara teratur dihidupkan dan dimatikan oleh peralatan tersebut

MULAI MENGGUNAKAN

- 1 Sebelum penggunaan pertama:** Kelupas semua bahan pembungkus seperti plastik, stiker, atau label yang mungkin menempel pada bodi, mangkuk, atau aksesoris. Bersihkan perabot dan aksesori-nya, lihat petunjuk: "Pembersihan dan Perawatan".
- 2 Siapkan bahan makanan:** Cuci bahan makanan hingga bersih. Potong-potong menjadi 4 sampai 6 bagian dan buang biji yang keras. Kupas kulit yang tebal pada buah atau sayuran.
- 3** Pasang komponen pisau blender (E) pada bagian atas dudukan pisau blender (F) dan kencangkan gelas (D) hingga posisinya terkunci. Pasang gelas pada bodi blender (A) lalu putar ke kanan hingga terkunci ke posisinya. (Gelas hanya dapat dipasang pada satu posisi). Setelah terkunci, simbol (✓) pada dudukan komponen pisau akan sejajar dengan simbol (Λ) pada bodi blender. Masukkan bahan makanan ke dalam gelas. (Jangan melebihi batas maksimal yang tertera pada gelas.)
Peringatan! Selalu pasang cincin perapat di sekeliling pisau blender sebelum mengoperasikan produk. Hanya gunakan cincin perapat yang disediakan oleh Electrolux!
- 4 Pasang tutup dengan menyejajarkan tuas pada tutup dengan gagang gelas. Pasang cangkir ukur.** (Anda dapat menambahkan bahan makanan lain melalui lubang tuang. Jangan melepas cangkir ukur atau tutup saat produk sedang dioperasikan.)
Peringatan! Jangan menghidupkan blender jika gelas kosong. Jika mengolah cairan yang panas, lihat langkah 5.
- 5 Mengolah cairan yang panas:** Sebaiknya dinginkan cairan (maks. 90 °C) sebelum dimasukkan ke dalam gelas. Isi gelas hanya setengahnya dan mulailah mengolah dengan kecepatan rendah. Gelas blender dapat menjadi panas – pastikan tangan Anda terlindungi dan keluarkan uap terlebih dulu melalui lubang tuang. Selalu pasang tutup sebelum mulai menggunakan blender.

- 6 **Hidupkan blender:** Tancapkan steker ke stopkontak. Tekan tombol ON/OFF (C). Tombol akan menyala. Tekan tombol kecepatan 1 atau 2 untuk memilih kecepatan yang diinginkan.
- 7 **Perhatian! Jangan memasukkan tangan atau benda apa pun ke dalam gelas saat blender sedang beroperasi.**
Perhatian! Jangan menghidupkan blender jika gelas kosong, karena blender dapat menjadi sangat panas dan dapat merusak produk.
- 8 **Tersedia pengaturan kecepatan (1, 2), program resep khusus, dan mode Pulse.** Kecepatan atau program resep yang dipilih akan menyala. Blender akan beroperasi sesuai durasi program yang dipilih. Tekan salah satu tombol untuk menghentikan program.
- 9 **Anda dapat mencampurkan bahan lain untuk mendapatkan konsistensi yang diinginkan dengan fungsi Pulse.** Tekan tombol PULSE (s) untuk menggunakan mode Pulse. Tombol PULSE dan kecepatan akan berkedip. Tekan 1, 2 untuk menggunakan kombinasi fungsi dan kecepatan.
- 10 **Produk memiliki program khusus untuk berbagai resep.** Anda dapat memilih antara fungsi Penghancur es (O) dan Smoothie (P). Blender akan otomatis berhenti setelah program selesai.

MENGGUNAKAN PISAU SERBAGUNA* (*HANYA MODEL TERTENTU)

- 11 **Balikkan posisi pisau serbaguna (J), dengan ujung yang terbuka berada di atas.** Lepaskan komponen mata pisau dengan hati-hati. (N) dengan hati-hati dengan cara memutarkannya ke kanan, lalu lepaskan rangkaian mata pisau (M). Isi toples serbaguna dengan bahan makanan yang akan diolah. Jangan mengisi lebih dari setengah kapasitas toples. Pasang dukungan komponen pisau serbaguna (I) pada toples dengan cara memutarkannya ke kiri untuk mengencangkannya. Balikkan posisi pisau serbaguna dan pasang ke bodi blender dengan cara memutarkannya ke kanan hingga posisinya terkunci.
Catatan: Setelah terkunci, simbol (V) pada komponen pisau serbaguna akan sejajar dengan simbol (A) pada bodi blender.
Peringatan! Mata pisau sangat tajam!

MENGGUNAKAN BOTOL MINUM* (*HANYA MODEL TERTENTU)

- 12 **Masukkan bahan makanan ke dalam botol minum (I).** Pasang komponen pisau* (E) pada toples dan kencangkan dukungan komponen pisau blender (F) dengan cara memutarkannya. Balikkan botol minum. Pasang botol minum yang sudah dirangkai ke bodi blender (A) dan putar ke kanan untuk mengunci posisinya.
Catatan: Setelah terkunci, simbol (V) pada dukungan komponen pisau blender akan sejajar dengan simbol (A) pada bodi blender.
Perhatian! Mata pisau sangat tajam!

MENGGUNAKAN STIK PENDINGIN* (*HANYA MODEL TERTENTU)

- 13 **Stik pendingin mempertahankan suhu dingin smoothie lebih lama.** Buka tutup stik pendingin (K) dan isi dengan air keran. Pasang kembali tutup stik dan masukkan stik ke dalam freezer hingga air di dalamnya membeku.
- 14 **Masukkan stik pendingin yang telah beku ke dalam botol minum.** Tuangkan jus segar yang telah diblender ke dalam botol minum (I) dan pasang tutup botol dengan tali (J). Stik pendingin dapat dibersihkan menggunakan mesin pencuci piring.

PEMBERSIHAN DAN PERAWATAN

Untuk menghindari keretakan pada gelas, selalu bilas dengan air bersih setelah digunakan. Hal ini akan mencegah kerusakan pada plastik yang disebabkan oleh asam atau minyak esensial dari bahan makanan yang diolah. Setelah dibilas, gelas kemudian dapat dicuci secara manual menggunakan deterjen, atau dimasukkan ke dalam mesin pencuci piring. Jangan membiarkan hasil olahan bahan makanan (seperti sup, smoothie, atau jus) berada di dalam gelas untuk waktu yang lama, terutama untuk yang bersifat asam (seperti lemon).

Jika muncul retakan, efek ini hanyalah sebatas pada permukaan dan tidak berdampak pada kekuatan dinding gelas.

15 Bilas gelas dengan seksama menggunakan air bersih sebelum memasukkannya ke dalam mesin pencuci piring.

Pembersihan cepat: Tuangkan air hangat ke dalam gelas, tambahkan beberapa tetes deterjen. Blender air dan deterjen dengan menekan tombol PULSE, kemudian tombol kecepatan 2 beberapa kali. Terakhir, bilas gelas dengan air mengalir.

16 **Membersihkan bodi dan antarmuka blender:** Matikan blender dan cabut steker dari stopkontak. Lap bodi blender dengan kain lembap.

 **Peringatan!** Jangan sekali-kali merendam bodi blender, steker, atau kabel di dalam air atau cairan lainnya.

17 **Membersihkan gelas secara menyeluruh: Catatan! Komponen mata pisau tidak dapat dilepas.** Buka tutup dan cangkir ukur. Cuci bersih komponen mata pisau dengan air dan deterjen.

Perhatian! Berhati-hatilah saat membersihkan karena mata pisau sangat tajam!



 Semua komponen, kecuali bodi blender dapat dibersihkan menggunakan mesin pencuci piring.

Selamat menggunakan produk Electrolux baru Anda!

RESEP

Saat menggunakan pisau serbaguna untuk mencincang bahan makanan seperti bawang bombai dan daun bawang, terlebih dulu iris menjadi potongan dadu berukuran kurang dari 2,5 cm untuk hasil terbaik. Bahan makanan dengan tekstur keras seperti wortel dan seledri sebaiknya tidak dicincang.

DURASI WAKTU PEMROSESAN MAKSIMAL	KAPASITAS MAKSIMAL
1 menit	500 ml

KECEPATAN YANG DISARANKAN					
Resep	Bahan-bahan	Banyaknya		Waktu	Kecepatan
Puree sayuran mentah	Wortel	20-80	g	30 detik	2 (Maksimal)
	Kentang	20-80	g		
	Bawang bombai	20-80	g		
	Air	60-120	g		
Smoothie nanas-aprikot	Irisan nanas	200	g	≤ 60 detik	2
	Aprikot kering	20	g		
	Yogurt	250	g		
Sup untuk gelas mini	Wortel	250	g	≤ 60 detik	2
	Air	350	ml		
Sup untuk botol minum	Wortel	210	g	≤ 60 detik	2
	Air	290	ml		
Smoothie rasberi	Rasberi beku	150	g	Pengaturan program	
	Pisang (½ buah)	50	g		
	Air	50	g		
	Yogurt	250	g		
Milkshake	Susu	100-200	ml	Pengaturan program	
	Es krim vanilla	100-150	ml		
	Pisang	¼ - ½	Butir		
	Sirup cokelat	30-60	g		

KECEPATAN YANG DISARANKAN

Resep	Bahan-bahan	Banyaknya		Waktu	Kecepatan
Sup kentang daun bawang	Kentang	60	g		2
	Daun bawang	60	g		
	Air	180	g		
Sup jamur	Mentega	75	g	Pengaturan program	2
	Bawang bombai	100	g		
	Jamur kancing	340	g		
	Kaldu ayam	900	ml		
	Garam dan merica	1	sejumput		
	Sherry	56	ml		
Pesto potong	Kemangi segar	30	g	≤ 30 detik	2
	Minyak zaitun	108	g		
	Kacang pinus	16	g		
	Bawang putih cincang	10	g		
	Garam	6	g		
	Keju Parmesan parut	50	g		
	Keju Romano parut	30	g		
	Mentega	42	g		
Hummus tekstur setengah kasar	Buncis kalengan	200	g		2
	Air lemon	2	tbbsp		
	Bawang putih geprek	2	Butir		
	Bubuk jintan	1	tsp		
	Garam	1	sejumput		
	Tahini (pasta wijen)	1	tbbsp		
	Air	4	tbbsp		
	Minyak zaitun extra virgin	2	tbbsp		
	Paprika	1	tsp		

FUNGSI PENGGIILING SERBAGUNA

Volume maksimal untuk cangkir serbaguna adalah 400 ml		Waktu pengolahan maksimal: 30 detik	
Bahan-bahan	Jumlah Maksimal	Waktu	Kecepatan
Kopi	60 g	20-30 detik	2
Udang kering	50 g	10 detik ON + 3 detik OFF (2 kali)	2
Cabai kering	20 g	10 detik ON + 3 detik OFF (2 kali)	2
Cabai segar	50 g	10 detik ON + 3 detik OFF (2 kali)	2
Butiran merica	100 g	10 detik ON + 3 detik OFF (2 kali)	2
Ikan teri kering	50 g	10 detik ON + 3 detik OFF (2 kali)	2
Beras	100 g	10 detik ON + 3 detik OFF (2 kali)	2
Lima jenis rempah	50 g	10 detik ON + 3 detik OFF (2 kali)	2
Bawang putih	50 g	5 detik ON + 3 detik OFF (5 kali)	2
Kacang	80 g	5-10 detik	2
Kacang almond	80 g	5-10 detik	2
Bawang bombai	100 g	5-10 detik	2
Daging sapi	100 g	5-10 detik	2

PEMECAHAN MASALAH

GEJALA	KEMUNGKINAN PENYEBAB	SOLUSI
Blender tidak dapat dihidupkan.	Gelas/bodi tidak terpasang dengan benar.	Pastikan semua komponen dipasang dengan posisi yang benar. Catatan! <i>Gelas hanya dapat diletakkan pada bodi blender dengan gagang sejajar dengan tombol antarmuka pengguna.</i>
	Tombol ON/OFF belum ditekan.	Tekan tombol ON/OFF untuk menghidupkan blender. Panel kontrol akan menyala ketika blender dihidupkan.
	Motor terlalu panas. Panel antarmuka berkedip.	Tunggu sampai produk agak dingin dan semua tombol menyala.
	Steker tidak tersambungkan ke stopkontak dengan benar.	Periksa sambungan steker ke stopkontak atau coba stopkontak lain.
	Listrik mati.	Tunggu sampai aliran listrik kembali.
	Masalah fungsional.	Hubungi pusat servis resmi.
Motor macet ketika sedang digunakan.		Apabila motor macet, segera matikan blender, cabut perabot dari sumber listrik dan dinginkan selama paling tidak 10 menit.
	Bahan makanan berukuran terlalu besar.	Iris semua buah dan sayuran bertekstur keras menjadi potongan yang berukuran kurang dari 1,8 cm ² sampai 2,5 cm ² .
	Bahan makanan yang diolah tidak sesuai.	Perabot ini ditujukan untuk membuat minuman. Tambahkan buah, sayuran atau bahan makanan lain yang serupa. Jangan sekali-kali mencampurkan bahan makanan seperti adonan, kentang tumbuk, daging atau semacamnya.
Apabila perabot masih tidak berfungsi, silakan hubungi Layanan Konsumen Electrolux.		

MEMBUANG PRODUK

Daur ulang bahan yang bertanda . Masukkan kemasan ke tempat sampah yang sesuai untuk didaur ulang. Bantu lestarikan lingkungan dan menjaga kesehatan dengan mendaur ulang limbah perabot listrik dan elektronik.



Jangan membuang perabot yang bertanda  sebagai limbah rumah tangga biasa. Bawa produk bekas ke fasilitas daur ulang setempat atau hubungi layanan pembuangan sampah di kota Anda.

LAYANAN KONSUMEN DAN SERVIS

Sebelum menghubungi Pusat Servis, siapkan data berikut ini: **Model, PNC, Nomor Seri**. Informasi tersebut dapat ditemukan pada pelat spesifikasi.

Sesuai kebijakan pengembangan produk Electrolux secara berkelanjutan; spesifikasi, warna, dan detail produk dan rincian yang tercantum dalam buku panduan ini dapat diubah tanpa pemberitahuan sebelumnya.

ขอขอบคุณที่เลือกใช้ผลิตภัณฑ์ของ ELECTROLUX และเพื่อรับประกันถึงผลลัพธ์ที่ดีที่สุด โปรดใช้อุปกรณ์เสริมและอะไหล่ของแท้จาก ELECTROLUX ซึ่งส่วนแต่ได้รับการออกแบบมาเป็นพิเศษสำหรับผลิตภัณฑ์ของคุณ ส่วนผลิตภัณฑ์นี้ได้รับการออกแบบมาโดยคำนึงถึงสิ่งแวดล้อม ชิ้นส่วนที่เป็นพลาสติกทั้งหมดทำเครื่องหมายเพื่อวัตถุประสงค์ในการรีไซเคิล

คู่มือแนะนำการใช้งาน

ภาพกราฟิกและภาพร่างในคู่มือนี้มิได้เพื่อประกอบคำอธิบายเท่านั้นและอาจจะแตกต่างจากผลิตภัณฑ์จริง กรุณาอ่านคำแนะนำทั้งหมดอย่างละเอียดก่อนใช้งานเครื่องเป็นครั้งแรก เก็บคู่มือนี้ไว้สำหรับอ้างอิงในอนาคต

ส่วนประกอบ

- | | | |
|---|--|----------------------------------|
| A. ฐานเครื่องปั่น | H. ถ้วยตวง | O. ปุ่มกดน้ำแข็ง |
| B. ขาดัง | I. ขวดขนาดพกพา* | P. ปุ่มสมูทตี้ |
| C. ปุ่มเปิด/ปิด | J. ฝาสำหรับเติมน้ำ พร้อมมีจับ | Q. ปุ่ม "ความเร็วระดับ 1" |
| D. โถใบเล็ก | K. แท่งทำความเย็น* | R. ปุ่ม "ความเร็วระดับ 2" |
| E. ชุดใบมีดของเครื่องปั่น พร้อมวงแหวนยาง | L. โถสับอเนกประสงค์* | S. ปุ่ม PULSE |
| F. ฐานติดตั้งชุดใบมีดของเครื่องปั่น | M. ชุดใบมีดสับอเนกประสงค์ พร้อมวงแหวนยาง* | |
| G. ฝาปิดโถปั่นใบเล็ก พร้อมช่องเติมอาหาร | N. ฐานติดตั้งชุดใบมีดสับอเนกประสงค์* | *บางรุ่นเท่านั้น |

ภาพในหน้า 2-4

คำแนะนำเพื่อความปลอดภัย

- แกะวัสดุที่มากับบรรจุภัณฑ์ออกให้หมดและทิ้งอย่างเหมาะสม ก่อนใช้ผลิตภัณฑ์
- เครื่องปั่นนี้ไม่ได้ออกแบบมาสำหรับการใช้งานโดยบุคคล (รวมถึงเด็ก) ที่มีความบกพร่องทางร่างกาย ทางประสาทสัมผัส หรือทางจิต รวมถึงผู้ที่ขาดประสบการณ์และความรู้ เว้นแต่จะอยู่ภายใต้การดูแลและการแนะนำการใช้เครื่องใช้ไฟฟ้าโดยผู้ที่รับผิดชอบความปลอดภัยของบุคคลเหล่านั้น
- เก็บเครื่องปั่นและสายไฟให้พ้นมือเด็ก ผู้ใหญ่ควรดูแลไม่ให้เด็กเล่นเครื่องปั่นนี้
- อย่าปล่อยให้เด็กทำความสะอาดและซ่อมบำรุงเครื่องปั่นด้วยตนเองโดยไม่อยู่ในความดูแลของผู้ใหญ่
- เครื่องปั่นต้องต่อเข้ากับแหล่งจ่ายไฟที่มีแรงดัน ไฟฟ้าและความถี่สอดคล้องกับค่าที่ระบุบนป้ายแสดงข้อมูลทางเทคนิคเท่านั้น
- ห้ามใช้หรือซื้อเครื่องปั่นที่สายไฟ/ตัวเครื่องเสียหาย
- หากเครื่องปั่นหรือสายไฟชำรุด ต้องให้อิเลคโตรลิกซ์หรือตัวแทนด้านการซ่อมบำรุงของบริษัทเป็นผู้เปลี่ยนชิ้นส่วน ทั้งนี้เพื่อป้องกันอันตรายที่อาจเกิดขึ้นได้
- ห้ามจุ่มเครื่องปั่น สายไฟหรือปลั๊กไฟลงในน้ำหรือของเหลวใดๆ
- ห้ามใช้งานหรือวางเครื่องปั่นใกล้กับขอบโต๊ะหรือขอบเคาน์เตอร์ ใกล้กับไอร้อน เตาไฟ เตาไฟฟ้าหรือเตาอบที่ร้อนอยู่
- วางเครื่องปั่นบนพื้นราบและแห้งเสมอ
- ปิดสวิตช์เครื่องปั่นและถอดปลั๊กเครื่องปั่นทุกครั้งที่ไม่ใช้งาน รวมทั้งก่อนการเปลี่ยนชิ้นส่วนอุปกรณ์เสริม การทำความสะอาดหรือการซ่อมบำรุง
- ใบมีดและอุปกรณ์ด้านในคมมากและอาจทำให้บาดเจ็บได้ ดังนั้นจะต้องใช้ความระมัดระวังเมื่อเปลี่ยนอุปกรณ์เสริม หลังใช้งาน และระหว่างการทำความสะอาดและการบำรุงรักษา
- ห้ามสัมผัสใบมีดหรืออุปกรณ์ด้านในด้วยมือเปล่าหรือด้วยเครื่องใช้ในครัวขณะที่กำลังเสียบปลั๊กเครื่องปั่นและ/หรือขณะที่เครื่องปั่นกำลังทำงานอยู่
- อย่าพยายามถอดชุดใบมีดออก
- วางมือและเครื่องใช้ในครัวไว้ห่างจากเครื่องปั่นขณะที่กำลังใช้งานเพื่อป้องกันการบาดเจ็บอย่างรุนแรงหรือเครื่องปั่นเสียหาย
- ปิดเครื่องก่อนถอดโถปั่นออกจากฐานมอเตอร์ทุกครั้ง
- ห้ามเปิดทำงานหากไม่มีอาหารหรือของเหลวอยู่ในโถปั่น
- ห้ามปั่นอาหารโดยไม่ปิดฝา

- ห้ามใช้เครื่องต่อเนื่องเกิน 1 นาทีเมื่อปั่นส่วนผสมที่แข็งมาก
- โถปั่นไม่สามารถผสมหรือบดของแข็งหรือของแห้งได้ ยกเว้นก่อนนำแข็ง หากต้องการบดของแข็งหรือของแห้ง (เช่น ถั่ว ลูกอม ข้าว ฯลฯ) ให้ใช้เครื่องบดเนกประสงค์
- ใช้ความระมัดระวังขณะเทของเหลวร้อน ๆ ลงในโถปั่นเพราะของเหลวอาจจะกระเด็นออกมาได้เนื่องจากเกิดไอน้ำอย่างฉับพลัน
- ห้ามปั่นของเหลวที่กำลังเดือด (ไม่เกิน 90°C)
- ห้ามใส่อาหารเกินกว่าเครื่องหมายที่ระบุไว้บนอุปกรณ์
- ห้ามใช้เครื่องปั่นมาผสมสี อันตรายมาก เพราะอาจจะเปิดได้!
- ระวังไม่ให้สายไฟสัมผัสกับพื้นผิวที่ร้อนหรือวางเครื่องปั่นใกล้กับขอบโต๊ะหรือขอบเคาเตอร์
- ห้ามใช้อุปกรณ์เสริมหรืออะไหล่ที่ผลิตโดยผู้ผลิตรถจักรยานที่ไม่ได้แนะนำหรือจำหน่ายโดยอีเลคโตรล็กซ์เพราะอาจทำให้ผู้ใช้ได้รับบาดเจ็บได้
- อุปกรณ์นี้ผลิตขึ้นเพื่อใช้ภายในอาคารเท่านั้น
- อุปกรณ์นี้ผลิตขึ้นเพื่อใช้ภายในประเทศเท่านั้น อีเลคโตรล็กซ์จะไม่ยอมรับผิดต่อความเสียหายใดๆ ที่อาจเกิดขึ้นจากการใช้งานอย่างไม่เหมาะสมหรือไม่ถูกต้อง
- หากเปิดเครื่องปั่นทิ้งไว้โดยไม่ได้เลือกระดับความเร็วโปรแกรมใด ๆ เครื่องปั่นจะปิดทำงานโดยอัตโนมัติหลังจากผ่านไป 5 นาที
- คำเตือน: เพื่อหลีกเลี่ยงอันตรายจากการรีเซ็ตระบบตัววงจรเมื่อมีอุณหภูมิสูงอย่างไม่ตั้งใจ ห้ามจ่ายไฟให้แก่เครื่องปั่นผ่านอุปกรณ์สวิตช์ภายนอก เช่น ระบบจับเวลา หรือเชื่อมต่อกับวงจรที่ตามปกติแล้วจะเปิดปิดโดยใช้อุปกรณ์ดังกล่าว

เริ่มต้นใช้งาน

- 1 ก่อนใช้งานครั้งแรก:** แกะวัสดุที่ติดมากับบรรจุภัณฑ์ทั้งหมดออกก่อน เช่น พลาสติก สติกเกอร์หรือเท็กที่อาจติดมากับตัวเครื่อง โถหรืออุปกรณ์เสริมต่างๆ ทำความสะอาดเครื่องและอุปกรณ์เสริม ดูคำแนะนำในหัวข้อ “การทำทำความสะอาดและการดูแลรักษา”
- 2 เตรียมส่วนผสม:** ส่วนผสมให้สะอาด จากนั้นหั่นส่วนผสมเป็น 4-6 ชิ้น และนำส่วนผสม ๆ หรือเมล็ดออก ปอกเปลือกผลไม้หรือผักออก
- 3 ติดตั้งชุดใบมีดของเครื่องปั่น (E) ลงบนแท่นติดตั้งชุดใบมีดของเครื่องปั่น (F) จากนั้นหมุนโถปั่น (D) ให้แน่น จนกระทั่งล็อกเข้าที่ วางโถปั่นที่ติดตั้งใบมีดเสร็จแล้วลงบนฐานเครื่องปั่น (A) แล้วหมุนตามเข็มนาฬิกาจนกระทั่งล็อกเข้าที่ (ตำแหน่งที่ถูกต้องของโถปั่นมีเพียงตำแหน่งเดียว) หลังจากล็อกเข้าที่แล้ว เครื่องหมาย V บนแท่นชุดใบมีดจะขนานกับเครื่องหมาย A ที่อยู่บนฐานเครื่องปั่น ใส่ส่วนผสมลงในโถ (อย่าใส่ส่วนผสมมากเกินไปเกินกว่าเครื่องหมายที่ระบุไว้บนโถปั่น) **ข้อควรระวัง!** ติดตั้งวงแหวนยางไว้รอบ ๆ ชุดใบมีดของเครื่องปั่นเสมอก่อนจะใช้เครื่องปั่น ในช่วงวงแหวนยางที่ Electrolux ให้มาเท่านั้น!**
- 4 ปิดฝาโดยจัดตำแหน่งให้ปีกบนฝาตรงกับมือจับของโถปั่น จากนั้นวางถ้วยดวงลงไป** (คุณสามารถเติมส่วนผสมผ่านช่องกรองได้ระหว่างการบิน แต่ห้ามถอดถ้วยดวงหรือฝาดูกระหว่างปั่นส่วนผสม) **ข้อควรระวัง!** ห้ามเปิดทำงานหากโถปั่นว่างเปล่า เมื่อปั่นของเหลวร้อน กรุณาดูขั้นตอนที่ 5
- 5 การปั่นของเหลวร้อน:** เราแนะนำว่าควรทำให้อุ่นของเหลวร้อนเย็นลง (ไม่เกิน 90 °C) ก่อนจะเทลงในโถปั่น เทของเหลวลงไปไม่เกินครึ่งโถปั่น แล้วเริ่มปั่นด้วยความเร็วต่ำก่อน โถปั่นอาจจะร้อนมาก ดังนั้นหาอะไรมาป้องกันมือและระบายไอน้ำผ่านช่องกรอง ปิดฝาก่อนปั่นส่วนผสมเสมอ
- 6 เปิดเครื่องปั่นอาหาร:** เลียบปลั๊ก กดปุ่มเปิด/ปิด (C) ปุ่มต่าง ๆ จะสว่างขึ้น กดปุ่มระดับความเร็ว 1 หรือ 2 เพื่อเลือกความเร็วในการปั่นที่ต้องการ
- 7 ข้อควรระวัง! เก็บจานชามซ้อนล้อมและมือให้ห่างจากโถผสมระหว่างการบิน** **ข้อควรระวัง!** ห้ามเปิดเครื่องปั่นเปล่า ๆ เพราะอาจทำให้เครื่องปั่นร้อนเกินไปและเสียหายได้
- 8 คุณสามารถเลือกระดับความเร็ว (1, 2) ที่มีการตั้งค่าไว้ล่วงหน้า โปรแกรมทำอาหาร และโหมด Pulse ได้** ระดับความเร็วและโปรแกรมทำอาหารที่เลือกไว้จะสว่างขึ้น เครื่องปั่นจะทำงานจนกว่าจะจบโปรแกรม หากต้องการหยุดโปรแกรมด้วยตัวเอง ให้กดปุ่มใดก็ได้
- 9 คุณสามารถปั่นส่วนผสมแบบรวดเร็วจนได้ความละเอียดที่ต้องการโดยใช้ฟังก์ชัน Pulse** กดปุ่ม PULSE (S) เพื่อไปยังโหมด Pulse ปุ่ม PULSE และปุ่มระดับความเร็วจะเริ่มกะพริบ กดปุ่ม 1 หรือ 2 เพื่อพัลส์ด้วยความเร็วระดับที่ต้องการ
- 10 เครื่องปั่นรุ่นนี้มาพร้อมกับโปรแกรมทำอาหารมากมาย** คุณสามารถเลือกบดน้ำแข็ง (O) หรือสมูทตี้ (P) ได้ เครื่องปั่นจะหยุดทำงานโดยอัตโนมัติเมื่อจบโปรแกรมแล้ว

การใช้เครื่องสับเนกประสงค์* (* บางรุ่นเท่านั้น)

- 11** **คว่ำเครื่องสับเนกประสงค์ (J) ลง โดยหันปากขึ้นด้านบน** ถอดชุดใบมีดออกอย่างระมัดระวัง (N) โดยหมุนตามเข็มนาฬิกา จากนั้นจึงค่อยถอดชุดใบมีด (M) ออก ไปส่วนผสมที่ต้องการลงในโถเครื่องสับเนกประสงค์ แต่อย่าใส่เกินครึ่งโถ แล้วติดตั้งชุดใบมีดสับเนกประสงค์ (I) เข้ากับปากโถป็น ตามด้วยฐานชุดใบมีดสับเนกประสงค์ แล้วหมุนทวนเข็มนาฬิกาเพื่อติดตั้งให้แน่น
คว่ำเครื่องสับเนกประสงค์ลง แล้วล็อกบนฐานเครื่องป็นให้เข้าที่โดยหมุนตามเข็มนาฬิกา
หมายเหตุ: หลังจากล็อกเข้าที่แล้ว เครื่องหมาย \checkmark บนแท่นชุดใบมีดสับเนกประสงค์จะขนานกับเครื่องหมาย \wedge ที่อยู่บนฐานเครื่องป็น
ข้อควรระวัง! ใบมีดคมมาก!

การใช้ขวดขนาดพกพา* (* บางรุ่นเท่านั้น)

- 12** **เติมส่วนผสมลงในขวดขนาดพกพา (I)** ติดตั้งชุดใบมีด (E) เข้ากับปากของโถป็น จากนั้นติดตั้งแท่นชุดใบมีดของเครื่องป็น (F) โดยหมุนเข้ากับโถป็น แล้วคว่ำโถป็นลง วางโถป็นที่ติดตั้งใบมีดเสร็จแล้วลงบนฐานเครื่องป็น (A) แล้วหมุนตามเข็มนาฬิกาจนกระทั่งล็อกเข้าที่
หมายเหตุ: หลังจากล็อกเข้าที่แล้ว เครื่องหมาย \checkmark บนฐานติดตั้งชุดใบมีดของเครื่องป็นจะขนานกับเครื่องหมาย \wedge ที่อยู่บนฐานเครื่องป็น
ข้อควรระวัง! ใบมีดคมมาก!

การใช้แท่งทำความเย็น* (* บางรุ่นเท่านั้น)



- 13** **แท่งทำความเย็นจะช่วยให้สมรรถนะของคุณเย็นนานขึ้น** เปิดฝาแท่งทำความเย็น (K) แล้วเติมน้ำก๊อกลงไป ปิดฝาแท่งทำความเย็นกลับเข้าไปเหมือนเดิม จากนั้นนำไปแช่ในช่องฟรีซจนกว่าน้ำภายในแท่งจะกลายเป็นน้ำแข็ง
- 14** **ใส่แท่งทำความเย็นที่นำออกมาจากช่องฟรีซลงในขวดขนาดพกพา** จากนั้นส่วนผสมที่เพิ่งป็นเสร็จเรียบร้อยแล้วลงในขวดขนาดพกพา (I) แล้วปิดฝาสำหรับดื่มที่มีมือจับ (J) ด้านบน แท่งทำความเย็นสามารถล้างด้วยเครื่องล้างจานได้

การทำความสะอาดและการดูแลรักษา

เพื่อป้องกันไม่ให้เกิดรอยแตกบนโถ ควรล้างโถด้วยน้ำสะอาดทันทีหลังใช้งานทุกครั้ง เพื่อป้องกันไม่ให้กรดหรือน้ำมันจากส่วนผสมทำลายวัสดุส่วนที่เป็นพลาสติก หลังจากล้างโถป็นด้วยน้ำสะอาดแล้ว สามารถนำมาล้างด้วยน้ำยาล้างจานด้วยมือหรือด้วยเครื่องล้างจานได้

อย่าทิ้งอาหารที่ทำเสร็จแล้ว (เช่น ซุป สมูทตี้ น้ำผลไม้) ไว้ในโถป็นเป็นเวลานาน โดยเฉพาะอย่างยิ่งเมื่อผสมอาหารที่มีรสเปรี้ยว (เช่น มะนาว เลมอน)

หากโถแตกกลาย จะส่งผลเฉพาะความสวยงามเท่านั้น ไม่ส่งผลต่อการใช้งานโถป็น



- 15** แล้วจึงนำไปล้างในเครื่องล้างจาน
การทำความสะอาดแบบรวดเร็ว: เทน้ำอุ่นลงในโถป็น จากนั้นเติมน้ำยาล้างจานตามลงไปเล็กน้อย ผสมน้ำกับน้ำยาล้างจานให้เข้ากัน แล้วกดปุ่ม PULSE และป้ม ระดับความเร็ว 2 สองสามครั้ง จากนั้น ล้างโถป็นด้วยน้ำไหลจากก๊อก หลังใช้ทุกครั้ง ล้างโถป็นให้สะอาดด้วยน้ำเปล่าเท่านั้น
- 16** **การทำความสะอาดฐานเครื่องป็นและอินเทอร์เฟซอย่างหมดจด:** ปิดเครื่องป็น แล้วถอดปลั๊กออก เช็ดทำความสะอาดฐานเครื่องป็นด้วยผ้าชุบน้ำหมาด ๆ
-  **คำเตือน!** ห้ามจุ่มฐานเครื่องป็น ปลั๊ก หรือสายไฟในน้ำหรือของเหลวใด ๆ
- 17** **การล้างโถป็นอย่างหมดจด: หมายเหตุ! ชุดใบมีดถอดออกไม่ได้** ถอดฝาและถ้วยตวงออก ล้างชุดใบมีดในน้ำและน้ำยาล้างจาน **ข้อควรระวัง!** จีบอย่างระวังเพราะใบมีดคมมาก!
-  **ข้อควรระวัง!** ชิ้นส่วนทุกชิ้น ยกเว้นฐานเครื่องป็น สามารถนำเข้าเครื่องล้างจานได้

ขอให้มีความสุขกับผลิตภัณฑ์ Electrolux เครื่องใหม่!

สูตร

เมื่อใช้เครื่องสับเนื้อประกอบเครื่องในการสับส่วนผสมอย่างเช่นหัวหอมใหญ่และหอมแดง ให้หั่นส่วนผสมเป็นชิ้นเล็ก ๆ ไม่เกิน 2.5 ซม. เพื่อให้ได้ความละเอียดที่เหมาะสม ไม่แนะนำให้สับส่วนผสมที่มีเนื้อหยาบ เช่น แครอทและเซเลอรี่

เวลาเตรียมอาหารสูงสุด	ความจุสูงสุด
1 นาที	500 มล.

ความเร็วในการผสมที่แนะนำ*					
สูตร	ส่วนผสม	ปริมาณ		เวลา	ความเร็ว
ผักสดปั่น	แครอท	20-80	กรัม	30 วินาที	2 (ความเร็วสูงสุด)
	มันฝรั่ง	20-80	กรัม		
	หัวหอมใหญ่	20-80	กรัม		
	น้ำ	60-120	กรัม		
สมูทตี้สับปรด-แอปพริคอต	สับปรดหั่นแฉ่น	200	กรัม		2
	แอปพริคอตแห้ง	20	กรัม		
	โยเกิร์ต	250	กรัม		
ซूपสำหรับโถปั่นขนาดเล็ก	แครอท	250	กรัม	≤ 60 วินาที	2
	น้ำ	350	มล.		
ซूपสำหรับขวดขนาดพกพา	แครอท	210	กรัม	≤ 60 วินาที	2
	น้ำ	290	มล.		
ราสเบอร์รี่สมูทตี้	ราสเบอร์รี่แช่แข็ง	150	กรัม	ตั้งค่า โปรแกรม	
	กล้วย (½ ชิ้น)	50	กรัม		
	น้ำ	50	กรัม		
	โยเกิร์ต	250	กรัม		
มิลค์เชค	นม	100-200	มล.	ตั้งค่า โปรแกรม	
	ไอศกรีมวานิลลา	100-150	มล.		
	กล้วย	¼ - ½	ชิ้น		
	น้ำเชื่อมช็อกโกแลต	30-60	กรัม		
ซूपมันฝรั่งกับต้นลิค	มันฝรั่ง	60	กรัม		2
	ต้นลิค	60	กรัม		
	น้ำ	180	กรัม		
กัวคาโมเลเนื้อหยาบ	อะโวคาโดสุกแข็ง	2	ชิ้น		PULSE+ 1
	หอมแขก	1	ชิ้น		
	ผักชีสด	1/4	ถ้วย		
	น้ำมันาวคั้นสด	1 และ 1 1/2	ช้อน โต๊ะ		
	เกลือ	1	หยิบ มือ		
เพสโต้เนื้อหยาบ	ไบเบซิลสด	30	กรัม	≤ 30 วินาที	2
	น้ำมันมะกอก	108	กรัม		
	เมล็ดสน	16	กรัม		
	กระเทียมสับ	10	กรัม		
	เกลือ	6	กรัม		
	ชีสพาร์เมซานขูด	50	กรัม		
	ชีสโรมาโนขูด	30	กรัม		
	เนย	42	กรัม		

ความเร็วในการผสมที่แนะนำ*					
สูตร	ส่วนผสม	ปริมาณ		เวลา	ความเร็ว
ซัสมัสเนื้อกึ่งเนียน	ถ้วยลูกไก่กระป๋อง	200	กรัม		2
	น้ำเลมอน	2	ช้อนโต๊ะ		
	กระเทียม, บด	2	ช้อน		
	ยี่หร่าป่น	1	ช้อนชา		
	เกลือ	1	หยิบมือ		
	ดาฮินี (เมล็ดงาบด)	1	ช้อนโต๊ะ		
	น้ำ	4	ช้อนโต๊ะ		
	พริกปาปริกกา	2	ช้อนโต๊ะ		
	กระเทียม, บด	1	ช้อนชา		

ฟังก์ชันเครื่องสับออนกประสงค์			
ปริมาณสูงสุดสำหรับโถสับออนกประสงค์ 400 มล.		เวลาด่วนส่วนผสมแห้งสูงสุด: 30 วินาที	
ส่วนผสม	ปริมาณสูงสุด	เวลา	ความเร็ว
กาแฟ	60 กรัม	20-30 วินาที	2
กุ้งแห้ง	50 กรัม	เปิด 10 วินาที + ปิด 3 วินาที (2 ครั้ง)	2
พริกแห้ง	20 กรัม	เปิด 10 วินาที + ปิด 3 วินาที (2 ครั้ง)	2
พริกสด	50 กรัม	เปิด 10 วินาที + ปิด 3 วินาที (2 ครั้ง)	2
เมล็ดพริกไทย	100 กรัม	เปิด 10 วินาที + ปิด 3 วินาที (2 ครั้ง)	2
ปลาแอนโชวีแห้ง	50 กรัม	เปิด 10 วินาที + ปิด 3 วินาที (2 ครั้ง)	2
ข้าวคั่ว	100 กรัม	เปิด 10 วินาที + ปิด 3 วินาที (2 ครั้ง)	2
เครื่องพะโล้	50 กรัม	เปิด 10 วินาที + ปิด 3 วินาที (2 ครั้ง)	2
กระเทียม	50 กรัม	เปิด 5 วินาที + ปิด 3 วินาที (2 ครั้ง)	2
ถั่วเปลือกแข็ง	80 กรัม	5-10 วินาที	2
อัลมอนด์	80 กรัม	5-10 วินาที	2
หัวหอมใหญ่	100 กรัม	5-10 วินาที	2
เนื้อวัว	100 กรัม	5-10 วินาที	2

วิธีแก้ไขปัญหา

ลักษณะอาการ	สาเหตุที่อาจเป็นไปได้	วิธีแก้ปัญหา
เครื่องปั่น ไม่เปิดทำงาน	ติดตั้งโถกับฐานไม่ลงล็อก	ตรวจสอบให้แน่ใจว่าส่วนประกอบทั้งหมดอยู่ในตำแหน่งถูกต้อง หมายเหตุ! โถปั่นจะต้องวางบนฐานโดยหันมือจับมาจากอินเทอร์เน็ตเพชผู้ใช้นั้น
	ไม่ได้กดปุ่มเปิด/ปิด	กดปุ่มเปิด/ปิดเพื่อเปิดเครื่องปั่น แผลงควบคุมจะสว่างขึ้นมาเมื่อเครื่องปั่นเปิดทำงาน
	มอเตอร์ร้อนเกินไป ไฟของส่วนแสดงผลกระพริบ	รอให้เครื่องปั่นเย็นลงและปุ่มสว่างขึ้น
	ไม่ได้เสียบปลั๊กอย่างถูกต้อง	ตรวจสอบว่าเสียบปลั๊กดีหรือไม่ หรือลองเสียบกับเต้ารับอื่น
	ไฟดับ	รอกันกว่าไฟจะมา
	ปัญหาการทำงาน	ติดต่อผู้ให้บริการที่ได้รับอนุญาต
มอเตอร์หยุดทำงานระหว่างเตรียมอาหาร		หากมอเตอร์ดับกลางคัน ให้ปิดเครื่องผสมทันที จากนั้นถอดปลั๊กออก แล้วปล่อยทิ้งให้เย็นอย่างน้อย 10 นาที
	ส่วนผสมขึ้นใหญ่เกินไป	หันผลไม้และผักแข็ง ๆ ทั้งหมดให้เป็นชิ้นขนาดไม่เกิน 1.8 - 2.5 ตารางเซนติเมตร
	ส่วนผสมไม่เหมาะสม	ผลิตภัณฑ์นี้ออกแบบมาเพื่อใช้ทำเครื่องดื่ม เดิมผลไม้ ผัก หรือส่วนผสมที่คล้ายคลึงกัน ห้ามใส่แป้งโด มันบด เนื้อสัตว์ หรือส่วนผสมอย่างอื่นที่คล้ายคลึงกันลงในโถปั่นขนาดเล็ก
หากเครื่องปั่นยังไม่ทำงาน กรุณาติดต่อฝ่ายบริการลูกค้าของ Electrolux		

การกำจัดทิ้ง

รีไซเคิลวัสดุที่มีสัญลักษณ์  โดยเก็บอุปกรณ์คืนกล่องบรรจุและทิ้งในจุดที่เก็บรวบรวมเพื่อการรีไซเคิล ช่วยปกป้องสิ่งแวดล้อมและสุขภาพของเพื่อนร่วมโลก และทำการรีไซเคิลส่วนประกอบทางไฟฟ้าและอุปกรณ์อิเล็กทรอนิกส์

ห้ามทิ้งเครื่องที่มีสัญลักษณ์  ร่วมกับขยะในครัวเรือนตามปกติ โดยให้นำไปทิ้ง ณ จุดจัดเก็บที่เหมาะสมหรือติดต่อเจ้าหน้าที่ในพื้นที่

การดูแลและการให้บริการลูกค้า

เมื่อติดต่อฝ่ายบริการ คุณต้องเตรียมข้อมูลต่อไปนี้ไว้ให้พร้อม: **รุ่น, PNC, หมายเลขเครื่อง** โดยดูข้อมูลเหล่านี้ได้จากแผ่นป้ายระบุ

เนื่องจาก Electrolux มีนโยบายที่จะพัฒนาผลิตภัณฑ์อย่างต่อเนื่อง ส่วนของข้อมูลจำเพาะ สีและรายละเอียดของผลิตภัณฑ์และที่ปรากฏในคู่มือนี้อาจเปลี่ยนแปลงได้โดยไม่ต้องแจ้งให้ทราบ

Cảm ơn quý vị đã lựa chọn sản phẩm Electrolux. Để đạt được hiệu quả sử dụng cao nhất, luôn sử dụng phụ kiện và linh kiện thay thế chính hãng của Electrolux. Những chi tiết này được thiết kế riêng cho sản phẩm của quý vị. Sản phẩm này thân thiện với môi trường. Tất cả các chi tiết nhựa đều được dán nhãn phù hợp cho mục đích tái chế.

SÁCH HƯỚNG DẪN

Các biểu tượng đồ họa và bản vẽ trong sách hướng dẫn này chỉ nhằm mục đích minh họa và có thể thay đổi theo sản phẩm thực tế.

Đọc kỹ các hướng dẫn sau trước khi sử dụng thiết bị lần đầu.

Giữ lại các hướng dẫn này để tham khảo về sau.

CẤU TẠO

- | | | |
|---|---|--------------------------------|
| A. Chân đế máy xay | I. Chai có thể mang đi được* | O. Nút xay đá |
| B. Chân hút | J. Nắp uống chống tràn với tay cầm* | P. Nút làm Smoothie |
| C. Nút BẬT/TẮT (ON/OFF) | K. Thanh làm mát* | Q. Nút vận tốc số 1 |
| D. Bình nhỏ | L. Bình xay đa năng* | R. Nút vận tốc số 2 |
| E. Bộ dao xay với roăng chống tràn | M. Bộ lưỡi dao cắt đa năng với roăng chống tràn* | S. Nút xay nhồi (Pulse) |
| F. Bộ chân đế dao xay | | |
| G. Nắp đậy bình nhỏ với lỗ tiếp liệu | | |
| H. Cốc đo | N. Bộ chân đế dao cắt đa năng* | |

*Chỉ có ở một số loại máy

HÌNH ẢNH Ở TRANG 2-4

SAFETY ADVICE

- Loại bỏ và xử lý an toàn bất kỳ vật liệu bao bì nào trước khi sử dụng thiết bị.
- Không cho phép những người (bao gồm cả trẻ em) bị suy giảm năng lực thể chất, trí tuệ hoặc cảm giác, hay người thiếu kinh nghiệm và kiến thức sử dụng thiết bị này, trừ khi có sự giám sát hoặc hướng dẫn của người chịu trách nhiệm về vấn đề an toàn của họ.
- Giữ thiết bị và dây điện ngoài tầm tay trẻ em. Trẻ em phải được giám sát để đảm bảo chúng không nghịch phá thiết bị này.
- Không để trẻ em vệ sinh và bảo trì thiết bị khi không có người giám sát.
- Chỉ được cắm thiết bị vào nguồn điện có điện áp và tần số tuân thủ các thông số kỹ thuật trên biển thông số.
- Không bao giờ được sử dụng hoặc nhắc thiết bị lên nếu dây điện bị hỏng và/hoặc vỏ máy bị hỏng.
- Thiết bị hoặc dây nguồn bị hỏng phải được thay bởi Electrolux hoặc đại lý bảo dưỡng của Electrolux để tránh nguy hiểm.
- Không ngâm thiết bị, dây nguồn hoặc phích cắm của thiết bị trong nước hoặc bất kỳ chất lỏng nào.
- Không sử dụng hoặc đặt thiết bị gần bếp bàn hoặc kệ bếp, nguồn khí nóng, lò sưởi, bếp điện hoặc lò đun nóng.
- Luôn đặt thiết bị trên bề mặt phẳng, khô.
- Luôn ngắt kết nối thiết bị với nguồn điện nếu không có ai chú ý đến thiết bị và trước khi thay phụ kiện, vệ sinh hoặc bảo trì.
- Các lưỡi dao và các phụ kiện lắp thêm rất sắc. Nguy hiểm có thể gây thương tích. Cẩn thận khi thay phụ kiện, sau khi sử dụng và trong quá trình làm sạch và bảo trì.
- Không bao giờ dùng tay hoặc các vật nào khác để chạm vào lưỡi dao hoặc các phụ kiện lắp thêm trong khi máy đang được cắm điện và/hoặc trong quá trình vận hành.
- Không cố tháo lắp bộ lưỡi cắt.
- Giữ tay và dụng cụ tránh xa thiết bị trong quá trình vận hành để tránh nguy cơ bị thương nặng cho người hoặc gây hư hỏng thiết bị.
- Đảm bảo rằng thiết bị đã được tắt trước khi lấy bình ra khỏi chân máy có gắn động cơ.

- Không vận hành thiết bị khi không có thức ăn hoặc chất lỏng trong bình.
- Không bao giờ sử dụng máy mà không đậy nắp.
- Không sử dụng thiết bị liên tục trong vòng hơn 1 phút khi chế biến khối lượng lớn.
- Không được dùng bình để trộn hoặc nghiền các chất cứng và khô, trừ đá viên. Sử dụng lưỡi xay đa năng để nghiền các chất cứng và khô (ví dụ: hạt, kẹo, gạo ...)
- Cần thận khi đổ chất lỏng nóng vào thiết bị vì chất lỏng có thể bị trào ra khỏi thiết bị do đột ngột hấp hơi.
- Không bao giờ thao tác với chất lỏng đun sôi (tối đa 90°C).
- Không cho nguyên liệu vượt quá thể tích tối đa cho phép theo chỉ dẫn trên thiết bị.
- Không sử dụng thiết bị này để khuấy sơn. Nguy hiểm, có thể gây nổ!
- Không để dây nguồn tiếp xúc với các bề mặt nóng hoặc vắt lên cạnh bàn hoặc kệ bếp.
- Tuyệt đối không sử dụng các phụ kiện hoặc bộ phận của các nhà sản xuất khác mà Electrolux không khuyến nghị hoặc bán vì việc này có thể dẫn đến nguy cơ gây thương tích cho mọi người.
- Chỉ sử dụng thiết bị này trong nhà.
- Thiết bị này chỉ để sử dụng trong gia đình. Electrolux sẽ không chịu bất kỳ trách nhiệm pháp lý nào về hư hỏng có thể xảy ra do sử dụng không đúng cách hoặc sai mục đích.
- Nếu thiết bị để không, đang không cài đặt ở bất kỳ tốc độ hoặc chương trình nào, nó sẽ tự động tắt sau 5 phút.
- LƯU Ý: Để tránh nguy hiểm do vô tình cài đặt lại bộ phận ngắt nhiệt, không được lắp thêm thiết bị chuyển mạch bên ngoài, chẳng hạn như thiết bị hẹn giờ hoặc kết nối với một mạch điện thường xuyên được bật tắt.

BẮT ĐẦU SỬ DỤNG

- 1 Trước khi sử dụng thiết bị lần đầu tiên:** Loại bỏ hết tất cả các vật liệu bao bì như nhựa, băng dính hoặc thẻ được gắn trên phần bệ, phần thân máy hay trên các phụ kiện đi kèm của máy. Làm sạch thiết bị và phụ kiện, tham khảo hướng dẫn: "Làm sạch và Bảo Quản".
- 2 Chuẩn bị các nguyên liệu:** Rửa sạch nguyên liệu. Cắt nguyên liệu thành 4 đến 6 miếng và loại bỏ hạt cứng hoặc to. Lột bỏ lớp vỏ dày nếu nguyên liệu là trái cây hoặc rau củ.
- 3 Đặt bộ lưỡi dao của máy xay (E) lên trên chân đế dao (F) và vật chặt bình (D) cho đến khi khớp chặt vào vị trí. Đặt bình lên chân đế máy xay (A) và xoay theo chiều kim đồng hồ cho đến khi nó khớp vào vị trí. (Bình chỉ có thể được lắp ở một vị trí). Khi bị khóa, ký hiệu (✓) trên chân đế dao phải được căn thẳng với ký hiệu (Λ) trên chân đế máy xay. Cho nguyên liệu vào bình. (Không cho nguyên liệu vượt quá mức tối đa như chỉ định trên bình).
Chú ý! Luôn lắp roăng xung quanh bộ dao cắt máy xay trước khi vận hành. Chỉ sử dụng các roăng được cung cấp bởi Electrolux!**
- 4 Đậy nắp bằng cách cài cần gạt trên nắp thẳng hàng với tay cầm của bình. Lắp cốc đo vào.** (Bạn có thể thêm các nguyên liệu vào lỗ nạp liệu sau khi bạn bắt đầu chế biến. Không bao giờ tháo cốc đo hoặc nắp đậy trong khi vận hành thiết bị.)
Chú ý! Không bao giờ chạy máy rỗng. Khi chế biến các chất lỏng còn nóng, xem bước 5.
- 5 Chế biến các chất lỏng còn nóng:** Nên để nguội chất lỏng còn nóng (tối đa 90°C) trước khi đổ vào bình. Đổ đầy một nửa bình và bắt đầu cho máy chạy ở tốc độ thấp. Bình máy xay có thể trở nên rất ấm - cần thận kéo phông tay và cần cho hơi nóng thoát ra qua lỗ nạp liệu. Luôn đậy nắp lại trước khi sử dụng.
- 6 Khởi động máy xay:** Cắm phích vào ổ điện. Nhấn nút ON/OFF (C), các nút sẽ sáng lên. Nhấn nút tốc độ 1 hoặc tốc độ 2, để chọn tốc độ chế biến bạn mong muốn.
- 7 Thận trọng! Không cho tay và vật dụng vào bình khi máy đang xay.**
Chú ý! Không bao giờ chạy máy xay rỗng, chạy máy xay khi bình còn rỗng có thể làm nhiệt độ tăng quá cao và làm hỏng thiết bị.
- 8 Bạn có các tốc độ cài đặt trước (1, 2), các chương trình món ăn chuyên dụng, và chế độ Xay nhồi để lựa chọn.** Tốc độ hoặc công thức được chọn sẽ sáng lên. Máy xay sẽ chạy cho đến khi lập trình kết thúc. Để dừng bất kỳ chương trình nào bằng tay, nhấn một nút bất kỳ.
- 9 Bạn có thể trộn nhanh các nguyên liệu cho đều với chức năng Pulse.** Nhấn nút PULSE (S) để chuyển sang chế độ Pulse. Các nút PULSE và các nút tốc độ bắt đầu nhấp nháy. Nhấn 1 hoặc 2 để xay nhồi ở các tốc độ khác nhau.

- 10 Thiết bị đi kèm với một loạt các lập trình công thức món ăn.** Bạn có thể chọn giữa chế độ Xay đá (O) và Smoothies (P). Máy xay sẽ tự động dừng khi cài đặt đã sẵn sàng.

SỬ DỤNG MÁY XAY ĐA NĂNG MULTI-CHOPPER* (* CHỈ CÓ Ở CÁC KIỂU MÁY NHẤT ĐỊNH)

- 11 Lật ngược máy xay đa năng (J) lên, với đầu mở hướng lên trên.** Cẩn thận tháo bộ dao (N) ra bằng cách xoay theo chiều kim đồng hồ, sau đó tháo bộ dao (M) ra. Cho nguyên liệu mong muốn vào đầy bình xay đa năng. Không được đổ nguyên liệu đầy hơn nửa bình. Lắp bộ lưỡi dao đa năng (I), tiếp theo là chân đế dao vào đầu mở của bình và vặn chặt bình bằng cách xoay theo chiều kim đồng hồ. Tiếp theo là chân đế xoay theo chiều kim đồng hồ.
- Lưu ý:** Khi bị khóa, ký hiệu (V) trên chân đế dao đa năng nên được căn chỉnh thẳng hàng với ký hiệu (Λ) trên thân máy xay.
- Chú ý!** Các lưỡi dao rất sắc!

SỬ DỤNG CHAI CÓ THỂ MANG ĐI ĐƯỢC* (*CHỈ ĐỐI VỚI MỘT SỐ KIỂU MÁY NHẤT ĐỊNH)

- 12 Đổ các nguyên liệu vào chai mang đi được (I).** Đặt bộ dao (E) vào đầu mở của chai và vặn chặt chân đế dao (F) bằng cách vặn nó lên bình. Lật ngược chai lại. Đặt chai mang đi được vào chân đế dao (A) và xoay theo chiều kim đồng hồ để khóa lại cho đến khi nó khớp vào vị trí.
- Lưu ý:** Khi được khóa, ký hiệu (V) trên chân đế dao đa năng nên được căn chỉnh thẳng hàng với ký hiệu (Λ) trên chân đế máy xay.
- Chú ý!** Lưỡi dao rất sắc!

SỬ DỤNG THANH LÀM MÁT* (* CHỈ CÓ Ở CÁC KIỂU MÁY NHẤT ĐỊNH)

- 13 Thanh làm mát giúp món smoothies của bạn lạnh lâu hơn.** Tháo nắp của thanh làm mát (K) và đổ nước vào. Vặn nắp trên thanh làm mát lại và đặt thanh trong tủ đá cho đến khi nước đông đá.
- 14 Đặt thanh làm mát đã đông đá vào chai mang đi được.** Đổ hỗn hợp vừa được pha chế của bạn vào chai (I) và đóng chặt nắp uống có tay cầm (J). Thanh làm mát có thể làm sạch trong máy rửa bát.

VỆ SINH VÀ BẢO QUẢN

Để tránh làm rạn bình, luôn rửa bình bằng nước sạch ngay sau khi sử dụng. Điều này giúp ngăn ngừa axit hoặc tinh dầu từ các nguyên liệu có thể làm hỏng vật liệu nhựa. Sau khi tráng bình, có thể rửa bình bằng tay với chất tẩy rửa, hoặc đặt vào máy rửa chén để làm sạch.

Tránh để các món ăn đã chế biến xong (ví dụ như súp, smoothie, nước ép trái cây) trong bình trong một thời gian dài, đặc biệt đối với các nguyên liệu có tính axit (ví dụ như chanh).

Tuy nhiên, nếu có bị rạn, hoàn toàn lo do hiệu ứng hóa chất và không có bất kỳ tác động đến chất lượng của bình.

- 15 Luôn luôn rửa sạch bình bằng nước sạch trước khi cho bình vào máy rửa chén.**

Làm sạch nhanh: Đổ nước ấm vào bình, và thêm vài giọt chất tẩy rửa.

Hòa nước và chất tẩy rửa bằng cách ấn nút nhồi PULSE rồi nhấn nút tốc độ 2 vài lần.

Cuối cùng, rửa bình dưới vòi nước đang chảy.

- 16 Làm sạch toàn bộ chân máy xay và giao diện:** Tắt máy xay và rút dây điện. Lau chân máy xay bằng một miếng vải ẩm.

 **Cảnh báo!** Không bao giờ nhúng chân máy xay, phích cắm, hoặc dây điện của máy xay vào nước hoặc các chất lỏng khác.

- 17 Làm sạch toàn bộ bình:** Lưu ý! Bộ dao cắt không thể tháo rời được. Tháo nắp và cốc đo. Rửa bộ dao trong nước và chất tẩy rửa.

Chú ý! Thao tác cẩn thận, các lưỡi dao rất sắc!



 Tất cả các bộ phận, ngoại trừ chân máy xay, đều có thể làm sạch bằng máy rửa chén.

Hãy trải nghiệm sản phẩm Electrolux mới của quý vị!

CÔNG THỨC MÓN ĂN

Khi sử dụng máy cắt đa năng để cắt các nguyên liệu như hành củ và hành tây, hãy cắt các nguyên liệu thành từng miếng không quá 2,5cm để đạt độ nhuyễn tốt nhất. Không nên cắt các nguyên liệu cứng như cà rốt và cần tây.

THỜI GIAN XAY TỐI ĐA	CÔNG SUẤT TỐI ĐA
1 phút	500 ml

VẬN TỐC XAY ĐỀ XUẤT					
Công thức	Nguyên liệu	Số lượng		Thời gian	Tốc độ
Rau quả tươi dạng sệt (puree)	Cà rốt	20~80	g	30 s	2 (Tốc độ tối đa)
	Khoai tây	20~80	g		
	Hành	20~80	g		
	Nước	60~120	g		
Smoothie Dứa - mơ	Dứa cắt lát	200	g	≤ 60 s	2
	Quả mơ khô	20	g		
	Sữa chua	250	g		
Soup cho bình mini	Cà rốt	250	g	≤ 60 s	2
	Nước	350	ml		
Súp để cho vào chai mang đi	Cà rốt	210	g	≤ 60 s	2
	Nước	290	ml		
Smoothie Mâm xôi	Quả mâm xôi đông lạnh	150	g	Lập trình cài đặt	
	Chuối (½ quả)	50	g		
	Nước	50	g		
	Sữa chua	250	g		
Sữa lắc (milkshake)	Sữa	100-200	ml	Lập trình cài đặt	
	Kem vani	100-150	ml		
	Chuối	¼ - ½	Quả		
	Si-rô sô-cô-la	30-60	g		
Súp Khoai tây Tỏi tây	Khoai tây	60	g	2	
	Tỏi tây	60	g		
	Nước	180	g		
Chunky Guacamole	Bơ đã chín	2	Quả	Đập+ 1	
	Hành đỏ	1	Quả		
	Lá rau ngò tươi	1/4	cúp		
	Nước chanh tươi	1 và 1/2	muỗng bàn		
	Muối	1	nhúm		

VẬN TỐC XAY ĐỀ XUẤT

Công thức	Nguyên liệu	Số lượng		Thời gian	Tốc độ
Chunky pesto	Húng quế tươi	30	g	≤ 30 s	2
	Dầu ô liu	108	g		
	Hạt thông	16	g		
	Tỏi băm	10	g		
	Muối	6	g		
	Phô mai Parmesan nghiền	50	g		
	Phô mai Romano nghiền	30	g		
	Bơ	42	g		
Hummus mịn vừa	Đậu gà đóng hộp	200	g		2
	Nước chanh	2	muỗng bàn		
	Ớt củ tỏi, đã được nghiền	2	Quả		
	Thì là xay	1	muỗng cà phê		
	Muối	1	nhúm		
	Tahini (bột mè nhão)	1	muỗng bàn		
	Nước	4	muỗng bàn		
	Dầu ôliu nguyên chất	2	muỗng bàn		
Ớt cửa gà	1	muỗng cà phê			

CHỨC NĂNG CẮT ĐA NĂNG

Khối lượng cắt tối đa cho ly cắt đa năng: 400 ml		Thời gian nghiền khô tối đa: 30 giây	
Thành phần	Số lượng tối đa	Thời gian	Tốc độ
Cà phê	60 g	20-30 giây	2
Tôm khô	50 g	0 giây ON + 3 giây OFF (2 lần)	2
Ớt khô	20 g	0 giây ON + 3 giây OFF (2 lần)	2
Ớt tươi	50 g	0 giây ON + 3 giây OFF (2 lần)	2
Ngô hạt tiêu	100 g	0 giây ON + 3 giây OFF (2 lần)	2
Cá cơm khô	50 g	0 giây ON + 3 giây OFF (2 lần)	2
Gạo sống	100 g	0 giây ON + 3 giây OFF (2 lần)	2
Ngũ vị hương	50 g	0 giây ON + 3 giây OFF (2 lần)	2
Tỏi	50 g	5 giây ON + 3 giây OFF (5 lần)	2
Hạt khô	80 g	5-10 giây	2
Hạnh nhân	80 g	5-10 giây	2
Hành	100 g	5-10 giây	2
Thịt bò	100 g	5-10 giây	2

KHẮC PHỤC SỰ CỐ

HIỆN TƯỢNG	NGUYÊN NHÂN	CÁCH KHẮC PHỤC
Máy xay không khởi động được.	Bình/chân máy không được cố định đúng cách.	Kiểm tra xem tất cả các bộ phận đã được lắp đúng vị trí chưa. Lưu ý bình xay chỉ có thể được đặt trên chân đế máy xay với tay cầm hướng về giao diện người dùng.
	Chưa nhấn nút ON/OFF.	Nhấn nút ON/OFF để bật máy xay. Bảng điều khiển sẽ sáng lên khi máy xay được bật.
	Động cơ quá nóng. Màn hình nhấp nháy.	Chờ cho đến khi sản phẩm đã nguội bớt và tắt cả các nút đều bật sáng.
	Phích cắm không được cắm hoàn toàn vào ổ cắm điện.	Kiểm tra kết nối giữa phích cắm vào ổ cắm hoặc thử một ổ cắm khác.
	Mất điện.	Chờ cho đến khi có điện trở lại.
	Sự cố về chức năng.	Liên hệ với dịch vụ được ủy quyền.
Động cơ khựng lại khi máy đang chạy		Nếu động cơ khựng lại, tắt máy xay ngay, rút phích cắm điện của thiết bị và để nguội ít nhất 10 phút.
	Các nguyên liệu quá lớn.	Cắt tất cả trái cây và rau quả cứng thành từng miếng không lớn hơn 1,8cm ² đến 2,5cm ² .
	Nguyên liệu sai.	Thiết bị dự định sử dụng dùng để sản xuất đồ uống. Thêm trái cây, rau hoặc nguyên liệu tương tự. Không bao giờ trộn các nguyên liệu như bột, khoai tây nghiền, thịt hoặc các thứ tương tự.
Nếu thiết bị vẫn không hoạt động, vui lòng liên hệ Bộ phận Dịch vụ Khách hàng của Electrolux.		

VỨT BỎ

Tái chế các vật liệu có biểu tượng . Cho bao bì vào các thùng chứa thích hợp để tái chế. Góp phần bảo vệ môi trường và sức khỏe con người và tái chế chất thải từ các thiết bị điện và điện tử.

Không vứt các thiết bị có biểu tượng  chung với rác thải sinh hoạt. Gửi sản phẩm cho cơ sở tái chế tại địa phương của quý vị hoặc liên lạc với văn phòng thành phố của quý vị.

BỘ PHẬN CHĂM SÓC VÀ DỊCH VỤ KHÁCH HÀNG

Khi liên lạc với Bộ Phận Dịch Vụ, hãy đảm bảo rằng quý vị có sẵn các dữ liệu sau đây: **Model, PNC, Số Sê-ri**. Các thông tin này có thể được tìm thấy trên biển thông số.

Theo chính sách phát triển sản phẩm liên tục của Electrolux; các thông số kỹ thuật, màu sắc, và các chi tiết sản phẩm của chúng tôi và những gì được đề cập trong sổ tay hướng dẫn này có thể thay đổi mà không cần thông báo.

中国

伊莱克斯（中国）电器有限公司上海小家电分公司
中国，上海，静安区共和新路1968号大宁国际广场
8号楼606室

办公电话：+86 21 3178 1000

传真：+86 21 3387 0368

售后服务：+86 9510 5801

网站：www.electrolux.com.cn

台灣

新加坡商伊莱克斯股份有限公司 台灣分公司
22065新北市板橋區縣民大道2段68號9F

免付費客服專線：0800-888-259

傳真：886-2-8964-5269

電郵：service@electrolux.com.tw

網站：www.electrolux.com.tw

KOREA

Electrolux Korea limited

9F, Pine Avenue B,

100 Euljiro, Jung-gu, Seoul, Korea 04551

Korea

Tel : +82 2 6020-2200

Fax: +82 2 6020-2271-3

Customer Care Services : +82 1566-1238

Email : homecare.krh@electrolux.com

Website: www.electrolux.co.kr

INDONESIA

PT. Electrolux Indonesia

Electrolux Building

Jl.Abdul Muis No. 34,

Petojo Selatan, Gambir

Jakarta Pusat 10160

Indonesia

Tel: 021 – 50817300

Fax: 021 – 50817399

Customer Care Services: 0804 111 999

SMS: 0812 8088 8863

Email: customer-care@electrolux.co.id

Website: www.electrolux.co.id

PHILIPPINES

Electrolux Philippines, Inc.

10th Floor, W5th Avenue Building

5th Avenue Corner 32nd Street

Bonifacio Global City,

Taguig Philippines 1634

Trunkline: +63 2 737 4756

Domestic Toll Free: 1 800 10 845 care 2273

Customer Care Services: +63 2 845 care 2273

Email: wecare@electrolux.com

Website: www.electrolux.com.ph

THAILAND

Electrolux Thailand Co Ltd

Electrolux Building

14th Floor 1910 New Petchburi Road

Bangkapi, Huay Kwang

Bangkok 10310

Thailand

Tel: +66 2 725 9100

Fax: +66 2 725 9299

Customer Care Services: +66 2 725 9000

Email: customer-care-thai@electrolux.com

Website: www.electrolux.co.th

VIETNAM

Electrolux Vietnam Ltd

Floor 9th, A&B Tower

76 Le Lai Street

Ben Thanh Ward - District 1

Ho Chi Minh City

Vietnam

Tel: +84 8 3910 5465

Fax: +84 8 3910 5470

Customer Care Services: 1800-58-8899

Email: vncare@electrolux.com

Website: www.electrolux.vn

MALAYSIA

Electrolux Home Appliances Sdn Bhd

Lot C6, No. 28, Jalan 15/22,

Taman Perindustrian Tiong Nam,

40200 Shah Alam, Selangor

Malaysia

Customer Care Services Tel: +60 3 5525 0800

Customer Care Services Fax: +60 3 5524 2521

Email: malaysia.customer-care@electrolux.com

Website: www.electrolux.com.my

SINGAPORE

Electrolux SEA Pte Ltd

1 Fusionopolis Place, Galaxis

#07-10 (West Lobby)

Singapore 138522

Customer Care Services: +65 6727 3699

Fax: +65 6727 3611

Email: customer-care.sin@electrolux.com

Website: www.electrolux.com.sg

AUSTRALIA

Electrolux Home Care & Small Domestic Appliances

ABN 51 004 762 341

163 O'Riordan Street, Mascot, NSW 2020, Australia

Customer Service Phone: 1300 365 305

Website: www.electrolux.com

NEW ZEALAND

Electrolux Home Care & Small Domestic Appliances

A division of Electrolux (NZ) Limited

3-5 Niall Burgess Road, Mt. Wellington, Auckland,

New Zealand

Phone: (09) 9573 2220

Customer Service Phone: 0508 730 730

Website: www.electrolux.com

HONG KONG

大昌貿易行有限公司

電器維修中心

香港九龍灣啟祥道20號

大昌行集團大廈5樓

服務熱線: +(852) 3193 9888

電子郵件: dchead@ead.dch.com.hk

網頁: www.electrolux.com.hk

