



Electrolux

Instruction Book

UltimateTaste500

Air Fryer

E5AF1-600P

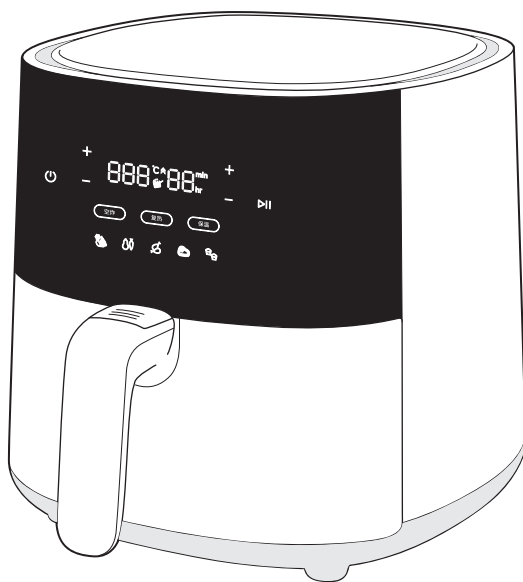

EN INSTRUCTION BOOK

CNS 说明书

WE'RE THINKING OF YOU

Thank you for purchasing an Electrolux appliance. You've chosen a product that brings with it decades of professional experience and innovation. Ingenious and stylish, it has been designed with you in mind. So whenever you use it, you can be safe in the knowledge that you'll get great results every time.

Welcome to Electrolux.

Visit our website to:



Get usage advice, brochures, trouble shooter, service information: www.electrolux.com



Register your product for better service: www.electrolux.com/productregistration



Buy accessories and consumables for your appliance: www.electrolux.com/shop

CUSTOMER CARE AND SERVICE

When contacting the service center, ensure that you have following data available. Model number, PNC, and serial number can be found on the rating plate.

Reference:

▼ 扫描二维码注册
www.electrolux.com.cn



QR Code
15 x 15 mm



Electrolux

型号: E5AF1-600P
 品名: 空气炸锅
 产品代码: 900 943 332
 类别: AF-F5010
 额定电压及频率: 220V~50Hz
 额定功率: 1400W
 严禁将器具浸入水中

Serial No.: **YWW00000**

产地: 浙江
 伊莱克斯 (中国) 电器有限公司
 DESIGN AND QUALITY BY ELECTROLUX SWEDEN/ ASSEMBLY IN CHINA

伊莱克斯 (中国) 电器有限公司

上海市虹口区公平路168号北外滩来福士广场办公楼30层

售后服务: +86 9510 5801

网站: www.electrolux.com.cn

Safety Advice

This appliance can be used by children aged from 8 years and above and persons with reduced physical, sensory or mental capabilities or lack of experience and knowledge if they are supervised or have received instruction concerning how to safely use the appliance and understand the hazards involved. Children shall not play with the appliance. Cleaning and user maintenance shall not be performed by children without supervision.

This appliance is not intended for use by persons (including children) with reduced physical, sensory or mental capabilities or lack of experience and knowledge, unless they have been given supervision or instruction concerning use of the appliance in a safe way and understand the hazards involved by a person responsible for their safety. Children should be supervised to ensure that they don't play with the appliance.

Please keep the air fryer and the power cord out of the reach of children less than 8 years.

This appliance is intended for normal household use only.

If the power cord is damaged or broken, it must be replaced by a service agent or similarly qualified persons to avoid safety hazards.

The accessible surfaces may become hot during use.

Do not cover the air inlet and the air outlet openings while the appliance is operating.

Always return the appliance to an authorized service center for examination or repair.

Do not attempt to repair the appliance yourself.

Do not place the appliance on or near a hot gas stove, any kind of electric stove, electric cooking plates or in a heated oven.

Always make sure that the plug is inserted into the socket properly.

Keep the mains cord away from hot surfaces or sharp objects to avoid damage.

Never put anything flammable, explosive or corrosive in the basket.

Do not excessively pinch, bend, twist or place heavy objects on the power cord to prevent from exposing or breaking its core.

Do not use the appliance if the plug, the main cord or the appliance itself is damaged.

Never start cooking without the basket being in place.

Do not fill up the basket above the "MAX" line in order to prevent food contact with the heating element. Do not touch the basket directly with your hands during or right after use to avoid getting scalded.

Do not use any plastic utensils or normal paper wrapping materials to wrap food for cooking.

Do not insert pins, wires or other objects into any of the openings of the air fryer to avoid an electrical shock or injury.

Please be sure to unplug the air fryer before cleaning or repairing it.

Do not move or shake the air fryer during use.

Do not insert any foreign objects into the safety switch to avoid any danger.

CAUTION: Hot surfaces. 

General Overview

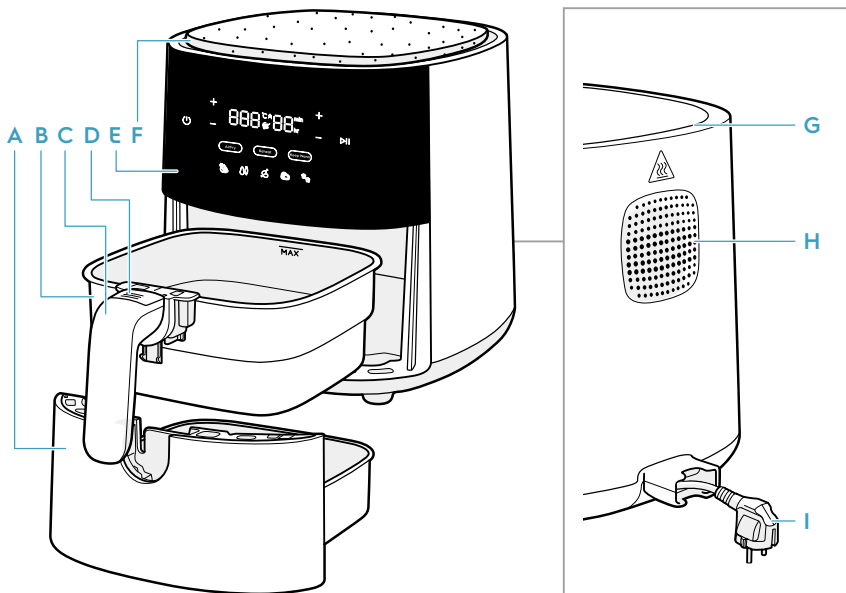

- | | | | |
|-----------------|-------------------------|----------------|--------------|
| A Pan | D Basket release button | F MultiCoaster | H Air outlet |
| B Basket | E Control panel | G Air inlet | I Main cord |
| C Basket handle | | | |

Accessories may vary from model to model

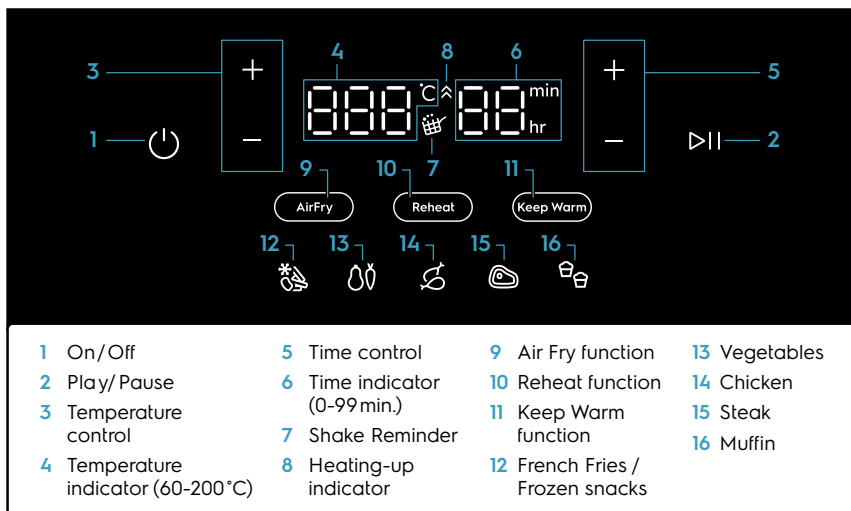

Before first use

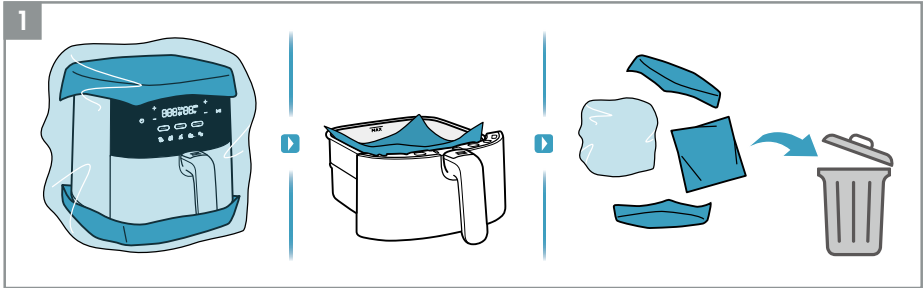

1. Remove all the packaging and protective material.

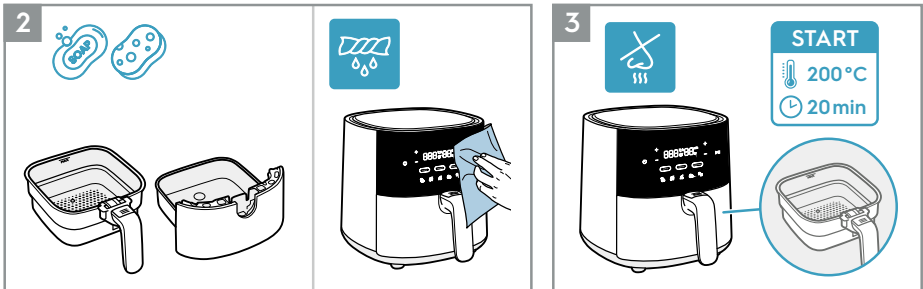

2. Clean the basket and pan with warm water and dish soap. Wipe inside and outside of the appliance with a soft cloth.
3. It is normal for a new unit to emit odors the first few times it is operated.
Run the empty air fryer at 200°C for 20 minutes before first use to avoid that.

How to use

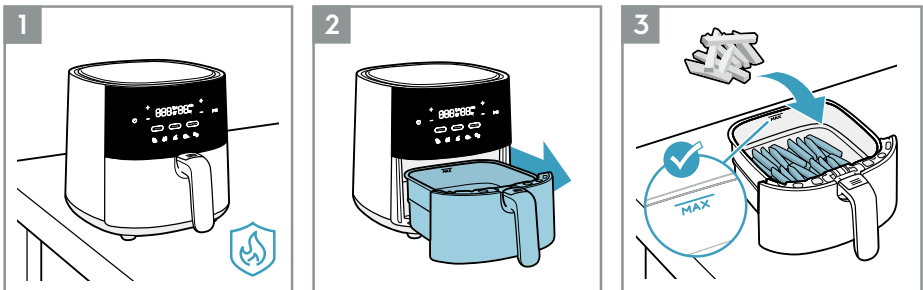

1. Place the appliance on a flat, stable and heat-resistance surface.
2. Pull out the pan and place it on a stable surface.
3. Put the food in the basket, observing the "MAX." capacity indication.

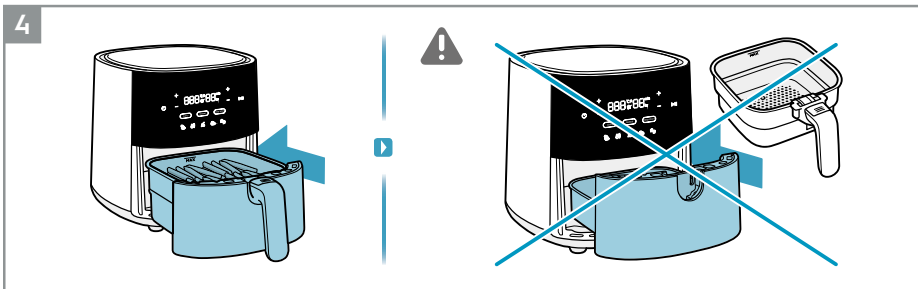

4. Push the pan with food completely back into the appliance.

⚠ CAUTION: Do not use the appliance without the basket.

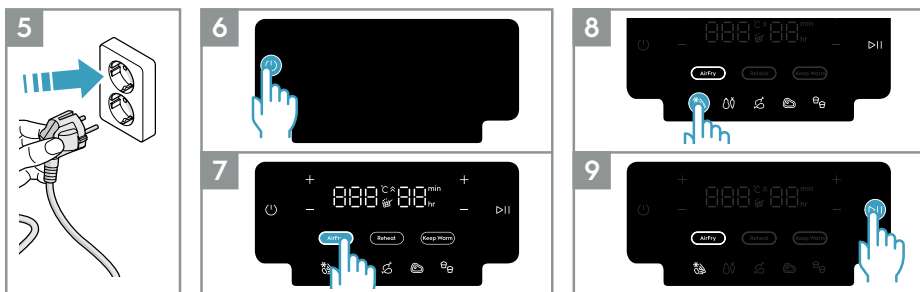

5. Plug in the appliance.

6. Press the On/Off button.

7. Select the desired cooking method. For example, Air Fry function.

8. Adjust the time and temperature to your taste or select one of the pre-set recipes. For example, French Fries.

9. Press the Play/Pause button.

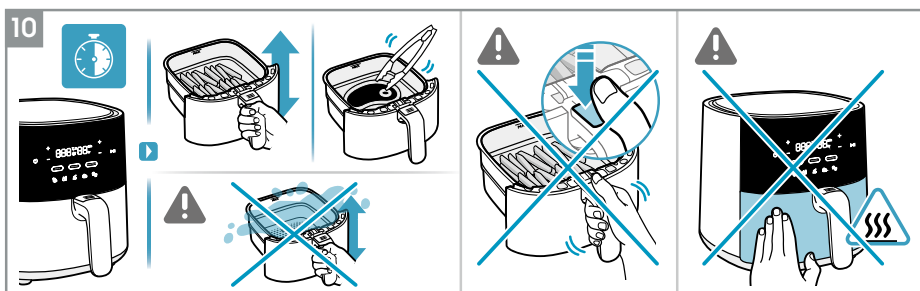

10. Depending on the type of ingredient, flip the food mid-cooking or every 7 minutes by using a heat-resistant tool or by just carefully shaking the food inside the basket. (see Cooking Guide).

⚠ CAUTION: Be careful not to press the "Basket Release Button" when shaking the food.

⚠ CAUTION: Be careful with hot surfaces when the appliance is in use.

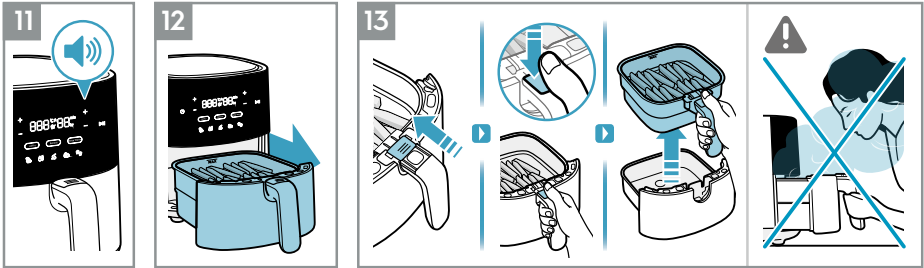

11. At the end of the cooking time, the appliance will issue a beep signal.

12. Carefully remove the pan and place it on a heat-resistant surface.

13. To remove the basket from the pan, follow these instructions:

- Slide the transparent button cover
- Press the "Basket Release Button"
- Lift the basket from the pan

⚠ CAUTION: Hot steam can come out of the basket when it is opened mid or at the end of cooking. Make sure your face, arms and hands are away from the steam when opening it.

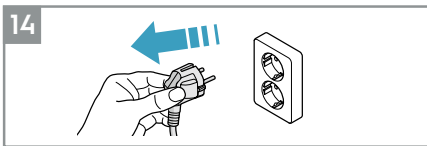

14. Unplug the appliance after using it.

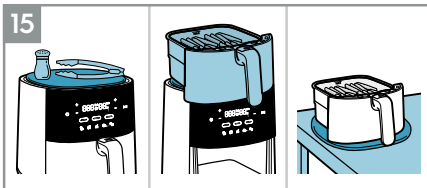

15. The versatile MultiCoaster fits on top of the air fryer as a space-saving hotplate for the cooking basket or resting place for tools and spices when cooking. It's also removable to use at the table when serving food from the hot basket.*

*Accessories may vary from model to model.

NOTE: Be careful with oil to avoid stains on the cork material.

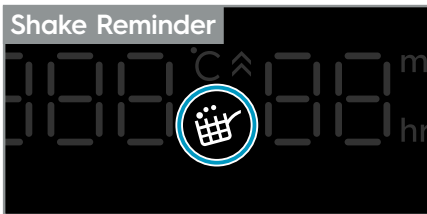































Shake Reminder

The "Shake Reminder" is activated during the pre-sets of some recipes, such as French Fries/Frozen Snacks, Vegetables and Chicken.

When it is time to shake or flip your food, the "Shake Reminder" icon will light up and blink for one minute, while a beep sound will repeat for three times.

The "Shake Reminder" is not mandatory, hence the cooking will continue as usual even if the food is not flipped or shaken.

Cooking Guide

|  |  |  |  |  |  |  |
|---|---|---|---|---|---|--|
|  7mm/10mm | 300-800g | 15-30min | 180°C |  | | |
|  7mm | 300-800g | 20-30min | 180°C |  | |  |
|  | 100-500g | 10-20min | 170°C |  | |  |
|  | 100-400g | 10min | 200°C | |  | |
|  | 100-200g | 10min | 200°C | |  | |
|  | 100-500g | 10-30min | 180°C | |  | |
|  | 100-500g | 13-20min | 180°C | |  | |
|  Max 1.2kg | 800-1200g | 45-60min | 180°C | |  | |
|  | 100-500g | 10-15min | 140°C | |  | |
|  | 100-500g | 10min | 180°C | |  | |
|  | 25-50g each | 10min | 170°C | | | |

Cleaning

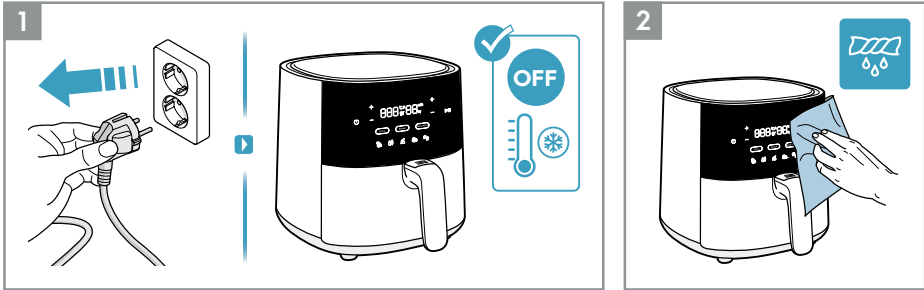

1. Always unplug the appliance and wait until it cools down before cleaning it.
2. Wipe the outside of the appliance with a soft cloth.

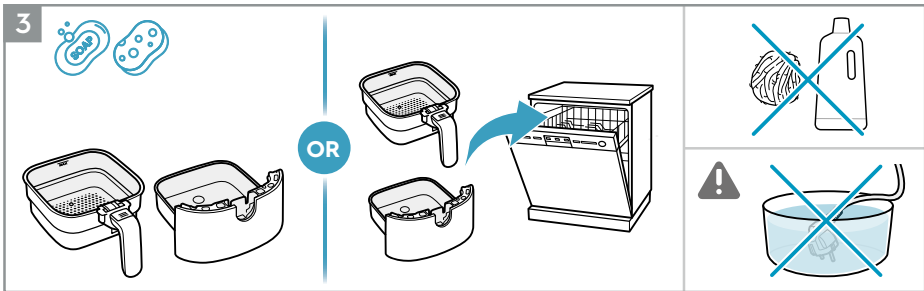

3. Clean the basket and pan with warm water and dish soap, or place them in the dishwasher.
- NOTE:** Avoid using abrasive cleaning products or metal tools in order to protect the non-stick coating.

CAUTION: Never submerge the product, its cord or plug in water or any other liquid.

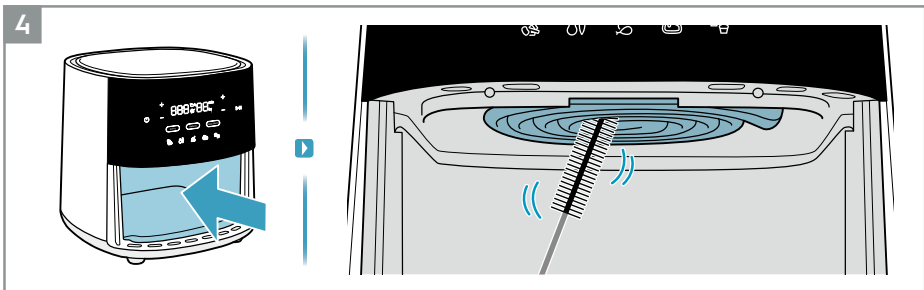

4. Clean the heating element with a cleaning brush.
- NOTE:** Ensure the appliance is completely cooled down before cleaning the heating element.

What to do if...

| Problem | Check if... |
|---|--|
| You cannot activate or operate the appliance. | <ul style="list-style-type: none"> • The appliance is correctly connected to an electrical supply. • The basket and pan are in the correct position. Ensure they are completely pushed into the appliance to enable the electrical supply. • The cooking time is set. |
| You cannot slide the pan into the appliance. | <ul style="list-style-type: none"> • The basket is filled over its maximum capacity. • The basket is placed correctly. It has to click when you place it in the pan. • There's an object under the pan that is an obstacle to close it properly. |
| White smoke comes out of the appliance. | <ul style="list-style-type: none"> • The food you prepare is too greasy. • The pan and the basket are clean. |
| The display shows E1 | <ul style="list-style-type: none"> • The temperature sensor is cutting out or disconnecting. |
| The display shows E2 | <ul style="list-style-type: none"> • The temperature sensor has short-circuited. |

* In case the display shows E1 or E2 error, the appliance must be repaired by a Service Center.

Disposal



This symbol on the product or on its packaging indicates that the product may not be treated as household waste. To recycle your product, please take it to an official collection point or to an Electrolux service center that can remove and recycle the battery and electric parts in a safe and professional way. Follow your country's rules for the separate collection of electrical products and rechargeable batteries.

Electrolux reserves the right to change products, information and specifications without notice.

我们为您着想

感谢您购买伊莱克斯电器。您选择了一款集数十年专业经验和创新为一身的产品。它制作精巧，外观时尚，细节设计无不为您着想。无论您何时使用，都可以完全放心，它将成为您生活中的出色助手。

欢迎使用伊莱克斯产品。

请访问我们的网站：



获得使用建议、产品手册、排查方法、服务信息：
www.electrolux.com



注册您的产品，获得更完善的服务：
www.electrolux.com/productregistration





为您的电器购买配件和耗材：
www.electrolux.com/shop

客户关爱与服务

当您联系服务中心时，请确保您已准备好以下信息。
产品型号、PNC和序列号，这些信息均可在商品铭牌上找到。

参考样式：

| | | | |
|---|---|--|---|
| ▼ 扫描二维码注册 | | www.electrolux.com.cn | |
| <div style="border: 1px dashed black; padding: 10px; text-align: center;"> <p>QR Code 15 x 15 mm</p> </div> |  <p>Electrolux</p> | <p>型号: E5AF1-600P 品名: 空气炸锅 产品代码: 900 943 332 类别: AF-F5010 额定电压及频率: 220V~50Hz 额定功率: 1400W 严禁将器具浸入水中</p> | |
| | | <p>Serial No.: YW00000</p> | |
| <p>产地：浙江 伊莱克斯（中国）电器有限公司 DESIGN AND QUALITY BY ELECTROLUX SWEDEN/ ASSEMBLY IN CHINA</p> | |  |  |

伊莱克斯（中国）电器有限公司

上海市虹口区公平路168号北外滩来福士广场办公楼30层

售后服务: +86 9510 5801

网站: www.electrolux.com.cn

安全建议

8岁及以上的儿童以及身体、感官或智力存在缺陷或缺乏经验和知识的人士如需使用本电器，应得到监督，或接受有关如何安全使用本电器并了解其危害的相关指导。儿童不得将此电器当作玩具。在没有监督的情况下，儿童不得进行清洁和维护。

本电器不适用于身体、感官或智力低下或缺乏经验和知识的人士（包括儿童）使用，除非他们得到监督或指导，能够以安全的方式使用该电器，并了解负责其安全的人员所涉及的危险。儿童应受到监督，以确保他们不会将此电器当作玩具。

请将空气炸锅和电源线放在8岁以下儿童接触不到的地方。

此电器仅供普通家庭使用。

如果电源线损坏，为了避免危险，必须制造商、其维修部或类似部门的专业人员更换。

可接触的表面在使用过程中可能会变烫。

当电器运行时，不要盖住进气口和出气口。

始终将电器送至授权的服务中心检查或维修。请勿试图自己修理电器。

请勿将电器放在热煤气炉、任何类型的电炉、电烹饪板上，或加热的烤箱或附近。

始终确保插头正确插入插座。

保持电源线远离热表面或尖锐物体，以免损坏。

切勿将易燃、易爆或腐蚀性物品放入炸篮。

请勿过度挤压、弯曲、扭曲电源线或在电线上压放重物，以免使芯线裸露或折断。

如果插头、电源线或电器本身已损坏，请勿使用电器。

炸篮放好之前，请勿开始烹饪。

为了防止食物接触加热元件，请勿让炸篮中的食物高度超过“最大”指示线。在使用过程中或使用后请勿直接用手触摸炸篮，以免烫伤。

请勿使用任何塑料器皿或普通的纸质材料来包裹烹饪食物。

请勿将针脚、电线或其他物体插入空气炸锅的任何开口处，以免触电或造成伤害。

在清洗或修理空气炸锅前，请务必拔掉插头。

使用过程中请勿移动或摇晃空气炸锅。

请勿将异物插入安全开关内，以免发生危险。

警告：灼热表面。 

器具不能在外接定时器或独立的遥控控制系统的方式下运行。

外观概览

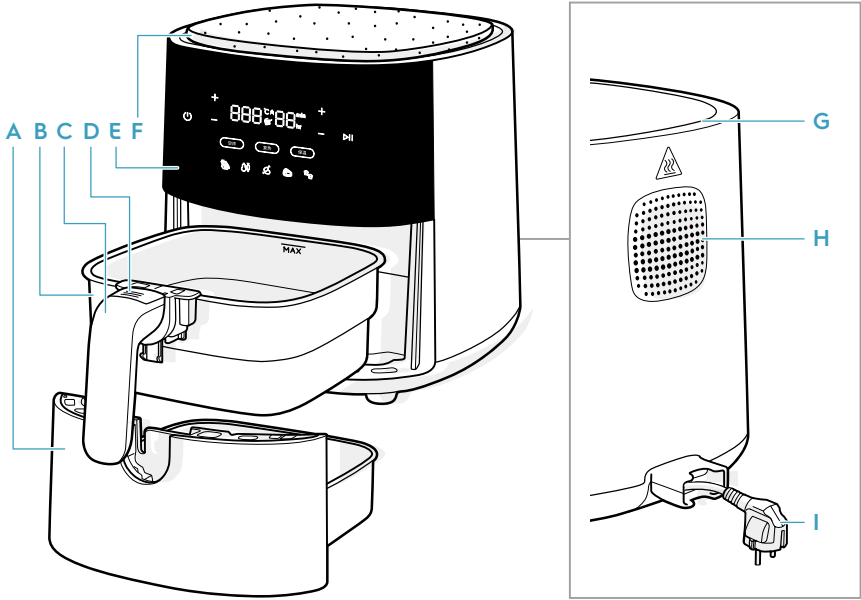

A 煎锅

B 炸篮

C 炸篮手柄

D 炸篮释放键

E 控制面板

F 隔热垫

G 进气口

H 出气口

I 电源线

配件可能因型号而异

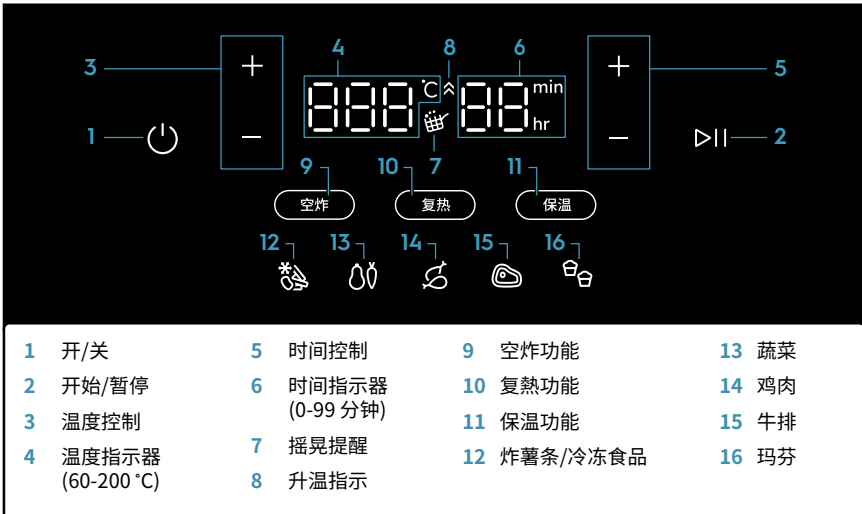

首次使用前

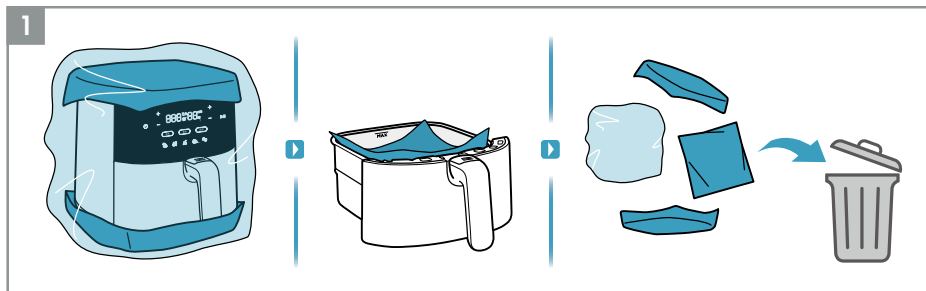

1. 拆除所有包装和防护材料。

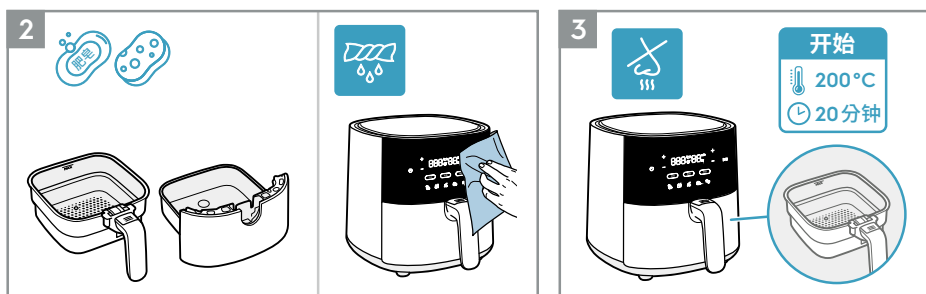

2. 用温水和洗洁剂清洗炸篮和煎锅。使用软布擦拭电器内外。

3. 新产品在最初几次使用时发出异味是正常现象。

首次使用前，让空气炸锅在200°C下空载运行20分钟，以避免这种情况。

使用方法

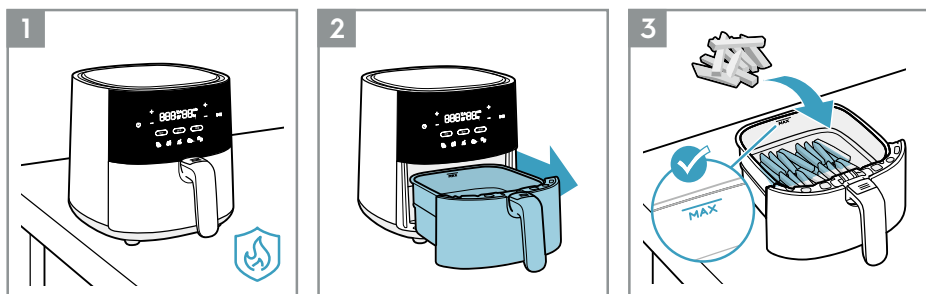

1. 将电器放在平坦、稳固、耐热的表面上。

2. 拿出煎锅，放在稳固的表面上。

3. 在炸篮里放入食物，同时观察“最大”最大容量指示线。

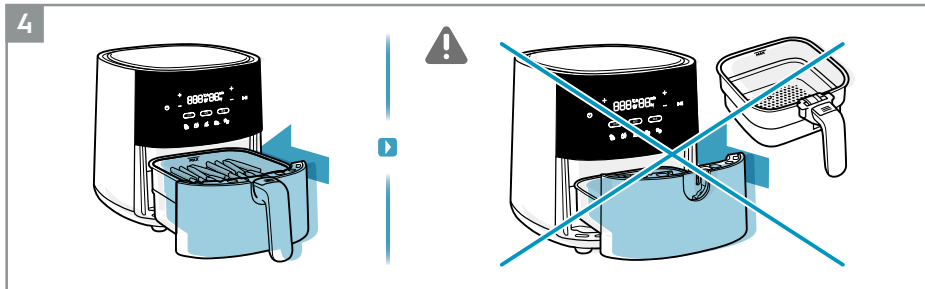

4. 将装有食物的煎锅完全推入电器。

▲警告：请勿在没有推入炸篮的情况下使用本电器。

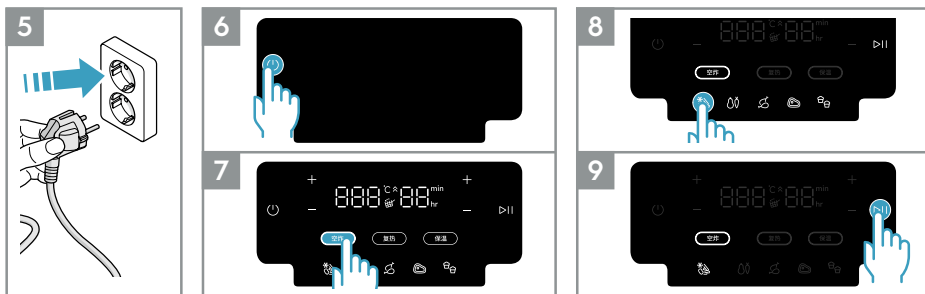

5. 将电器插头插入电源插座。

6. 按下“开/关”键。

7. 选择烹饪方式。例如空炸功能。

8. 根据您的口味调整时间和温度，或选择一种预设菜单。例如炸薯条。

9. 按下“开始/暂停”键。

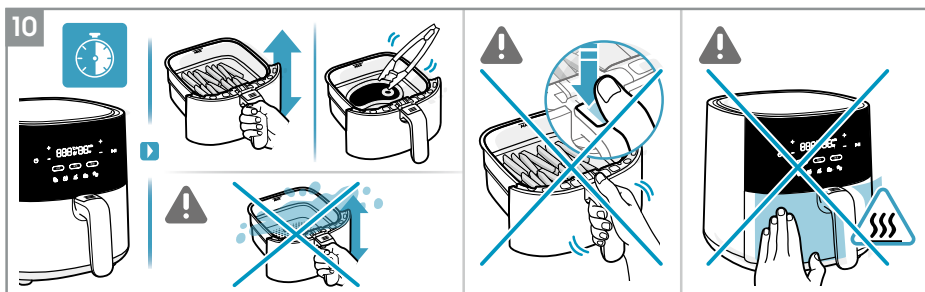

10. 根据配料的类型，在烹饪中途或每7分钟用耐热工具翻转一次食物，或者小心地轻微摇晃炸篮里的食物。（参见烹饪指南）。

▲警告：在摇晃食物时，请谨慎操作，切勿按下“炸篮释放键”。

▲警告：电器运转过程中，表面温度较高，请小心使用。

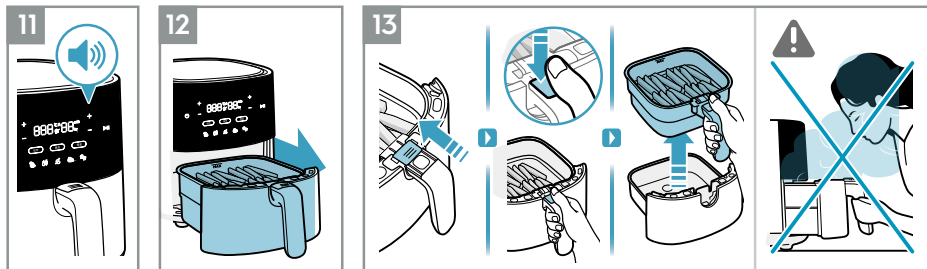

11. 烹饪计时结束后，电器会发出蜂鸣声。

12. 小心地取出煎锅，放置在耐热平面上。

13. 从煎锅中取出炸篮，步骤如下：

- 滑动透明的按钮盖
- 按下“炸篮释放键”
- 从煎锅中提起炸篮

▲ 警告：在烹饪中途或结束后打开炸篮，会冒出灼热蒸汽。请在打开时，确保您的面部、手臂和双手远离蒸汽。

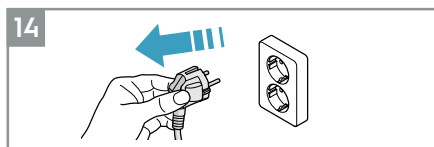

14. 使用过后，拔出电源插头。

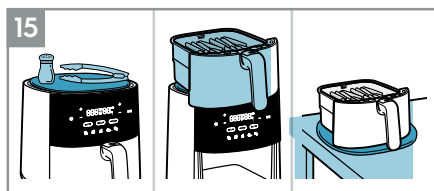

15. 这款空气炸锅可放置隔热垫，既可用于放置烹饪炸篮，以节省空间，也可在烹饪过程中放置厨具和调料。它也是可移动的，放在餐桌上，方便盛舀炸篮中的食物*

*配件可能因型号而异。

注意：小心烹饪产生的油脂，避免在软木材料上留下污渍。

摇晃提醒

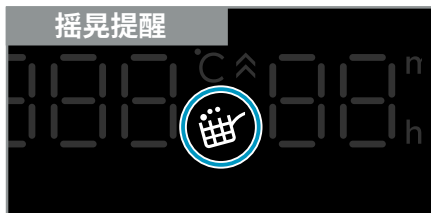

摇晃提醒

“摇晃提醒”会在一些食谱的预设中启动，例如炸薯条/冷冻食品、蔬菜和鸡肉。































当需要摇晃或翻转食物时，“摇晃提醒”图标会点亮并闪烁一分钟，同时发出三次蜂鸣声。

“摇晃提醒”不是强制性的，因此即使没有翻转或摇晃食物，烹饪也会照常进行。

烹饪指南

EN

CNS

|  |  |  |  |  |  |  油脂 |
|--|---|---|---|---|---|--|
|  7毫米/10毫米 | 300 ~ 800克 | 15 ~ 30分钟 | 180 °C |  | | |
|  7毫米 | 300~ 800克 | 20 ~ 30分钟 | 180 °C |  | |  |
|  | 100~ 500克 | 10 ~ 20分钟 | 170 °C |  | |  |
|  | 100~ 400克 | 10分钟 | 200 °C | |  | |
|  | 100~ 200克 | 10分钟 | 200 °C | |  | |
|  | 100~ 500克 | 10 ~ 30分钟 | 180 °C | |  | |
|  | 100~ 500克 | 13 ~ 20分钟 | 180 °C | |  | |
|  最大1.2 kg | 800~ 1200克 | 45 ~ 60分钟 | 180 °C | |  | |
|  | 100~ 500克 | 10 ~ 15分钟 | 140 °C | |  | |
|  | 100~ 500克 | 10分钟 | 180 °C | |  | |
|  | 25~ 50克/个 | 10分钟 | 170 °C | | | |

清洁方法

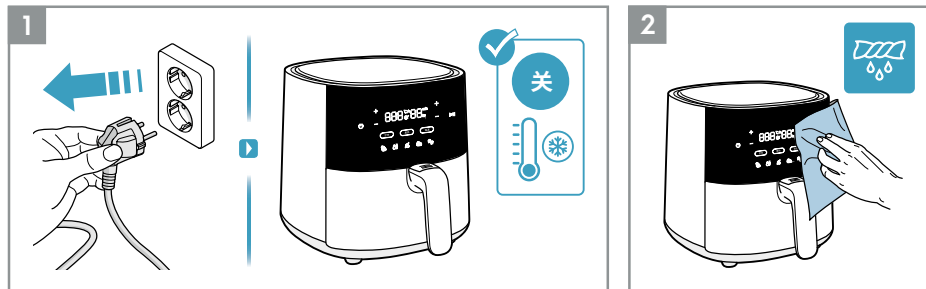

1. 清洁前，请务必拔下电器插头并等待设备冷却。

2. 使用软布擦拭电器表面。

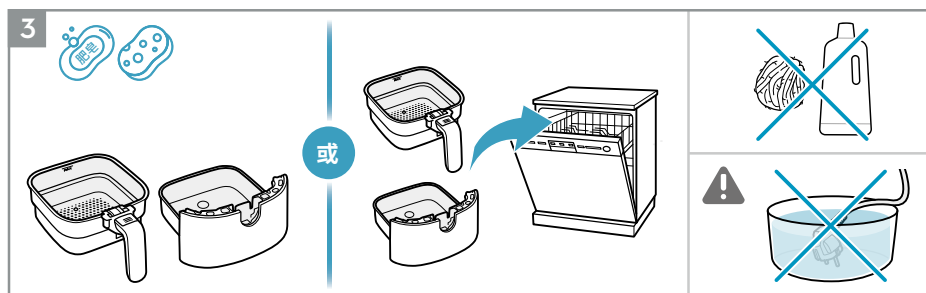

3. 使用温水和洗涤剂清洗炸篮和煎锅，或使用洗碗机清洗。

注意：避免使用研磨性清洁产品或金属工具，以免损伤防粘涂层。

▲ 警告：切勿将产品、电源线或插头浸入水或任何其他液体中。

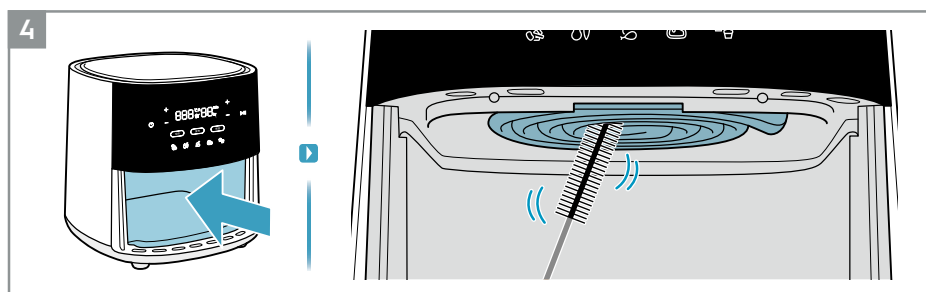

4. 使用清洁刷清洁加热元件。

注意：在清洁加热元件前，确保电器已完全冷却。

故障排除

| 问题 | 可能的原因 |
|------------|--|
| 无法启动或操作电器。 | <ul style="list-style-type: none"> · 电器与电源没有正确连接。 · 炸篮和煎锅没有处在正确位置。确保它们完全被推入电器以接通电源。 · 没有设定烹饪时间。 |
| 无法将煎锅推入电器。 | <ul style="list-style-type: none"> · 炸篮装填的食物已经超过最大容量。 · 炸篮没有放置到位。将炸篮正确放入煎锅后，应听到咔嗒声。 · 煎锅底部有异物，致使煎锅无法正确推入。 |
| 电器冒出白烟。 | <ul style="list-style-type: none"> · 您烹饪的食物含有过多油脂。 · 煎锅和炸篮非常干净。 |
| 显示屏出现E1 | <ul style="list-style-type: none"> · 温度传感器停止工作或断开。 |
| 显示屏出现E2 | <ul style="list-style-type: none"> · 温度传感器已经短路。 |

* 如果显示屏出现E1或E2报错信息，必须由服务中心对电器进行维修。

弃置



本产品或其包装上的这个标志说明该产品不可作为家庭垃圾丢弃。回收时，请携带该产品前往官方收集点或伊莱克斯（Electrolux）服务中心，以便以安全和专业的方式拆除并回收电池和电气部件。遵守您所在国家关于单独回收电气产品和充电电池的规定。

伊莱克斯（Electrolux）保留更改产品、信息和规格的权利，恕不另行通知。

有害物质含量信息 (to be updated)

食品接触材料符合性申明 (to be updated)

